

BarnGuide

Version 2.9

BarnGuide contents

- **BarnCare**..... 4
- **BarnOne series**..... 5
 - General information..... 6
 - Physical dimensions and mechanical accessories..... 7
 - Technical specifications..... 9
 - BarnOne - the variations..... 10
 - Functionality diagram..... 11
 - BarnOne frame with extended functionality - BTF1-10AA..... 12
 - BarnOne ordering information..... 15
- **Stage Box Break-Out**..... 17
 - Module based break-out panel..... 18
 - Stage box ordering information..... 19
- **BarnMini series**..... 21
 - BTF-Mini-16..... 22
 - BarnMini-01..... 23
 - BarnMini-02..... 24
 - BarnMini-03/04..... 26
 - BarnMini-05..... 27
 - BarnMini-06..... 30
 - BarnMini-07..... 31
 - BarnMini-08..... 32
 - BarnMini-11 33
 - BarnMini-12..... 34
 - BarnMini ordering information..... 35
- **LGX Series - Passive Optical Products**..... 37
 - Housing for LGX series..... 38
 - Optical Changeover Switch..... 38
 - Optical splitters..... 39
 - CWDM multiplexers..... 41
 - LGX series ordering information..... 42
- **SFPs**..... 43
 - How to read the SFP label..... 44
 - Data sheet examples..... 46
 - SFPs ordering information..... 50



• BarnAcademy	53
- Wavelength division multiplexing	54
- Coarse wavelength division multiplexing	54
- HiLo technology.....	55
- Optical budget calculation	56
- Light travelling through fiber.....	58
- The electromagnetic spectrum.....	59
• Software & Control	61
- BarnStudio - Installation.....	62
- Overview.....	63
- Device list.....	64
- Take list.....	65
- Basic information.....	66
- Network settings.....	67
- Matrix.....	69
- Inputs.....	70
- Outputs.....	71
- Signal redundancy switch.....	72
- AA-MADI - MADI Router with analog interfaces.....	74
- SFPs.....	76
- Firmware upgrade.....	77
- Diagnostics.....	78
- BarnMini-05 control.....	80
- Web User Interface.....	84
- Connecting 3rd party products.....	87
• Application examples	89
• Trouble shooting	99
- CAM-CCU in details.....	100
- CAM-CCU trouble shooting workflow.....	101
- Trouble shooting.....	104
- Questionnaire.....	108

BarnCare

Barnfind offers 2-YEAR standard warranty for all products. For BarnOne series (Frame, PSU, Fan Cassette), we offer an extra 3-YEAR warranty that can be purchased on request. For even longer warranty requests or other support agreements, please ask! See also **Business Partner Agreement (BPA)** for further information.

Note that the warranty and guarantee handling is to be done via the Business Partner that are seen as Barnfind's local preferred partner. It is the Business Partner that is responsible for the first line service/support to the End Users in the Territory. Barnfind will act accordingly after first line service/support is done by the Business Partner and the outcome is reported to Barnfind.

Support packages that the Business Partner offers are between the Business Partner and its client.

Barnfind will need the Business Partner to administer the warranty and support packages. This means in practice that the customer must forward defective equipment to the Business Partner. If the Business Partner cannot fix the problem the Business Partner forwards to Barnfind at its expense and Barnfind fixes the problem. Barnfind pays postage back to the Business Partner and the Business Partner forwards to its customer. This is a non- discountable service.

The Warranty covers repairs and fixes due to equipment faults that have occurred attributable to Barnfind. Warranty issues not attributable to Barnfind are not covered by this 24+ Warranty Plan. Barnfind shall have full and final jurisdiction in assessing the nature of its liability with regards to Warranty return. All costs related to sending equipment to Barnfind shall be borne by the Business Partner. All costs for sending equipment back to the Business Partner shall be borne by Barnfind.

Barnfind reserves the right to change its repair plan tariffs and terms at the end of each calendar year.



All Barnfind products come with standard 2 years warranty, but can be extended to 5 years.

Please ask your local distributor or directly contact Barnfind HQ.



BarnOne Series



BarnOne - general information



- 32x32 crosspoint matrix
- All SFP ports are bi-directional
- All BNC ports are inputs or outputs
- All outputs are reclocked
- Handles any MSA compliant SFP

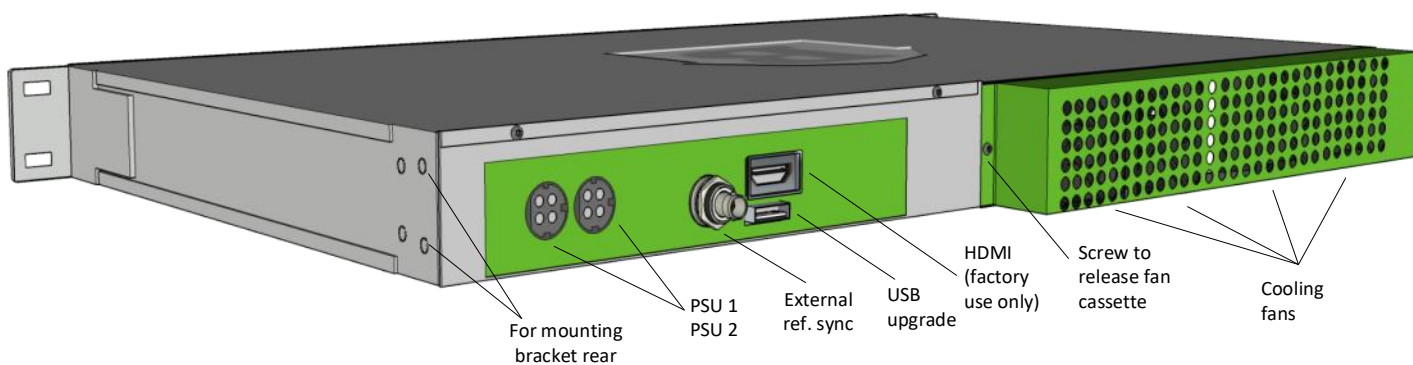

- Replaceable fan cassette
- Sync from external or internal source
- Redundant powersupply
- Front or rear mount in rack
- BarnStudio included

Physical dimensions and mechanical accessories

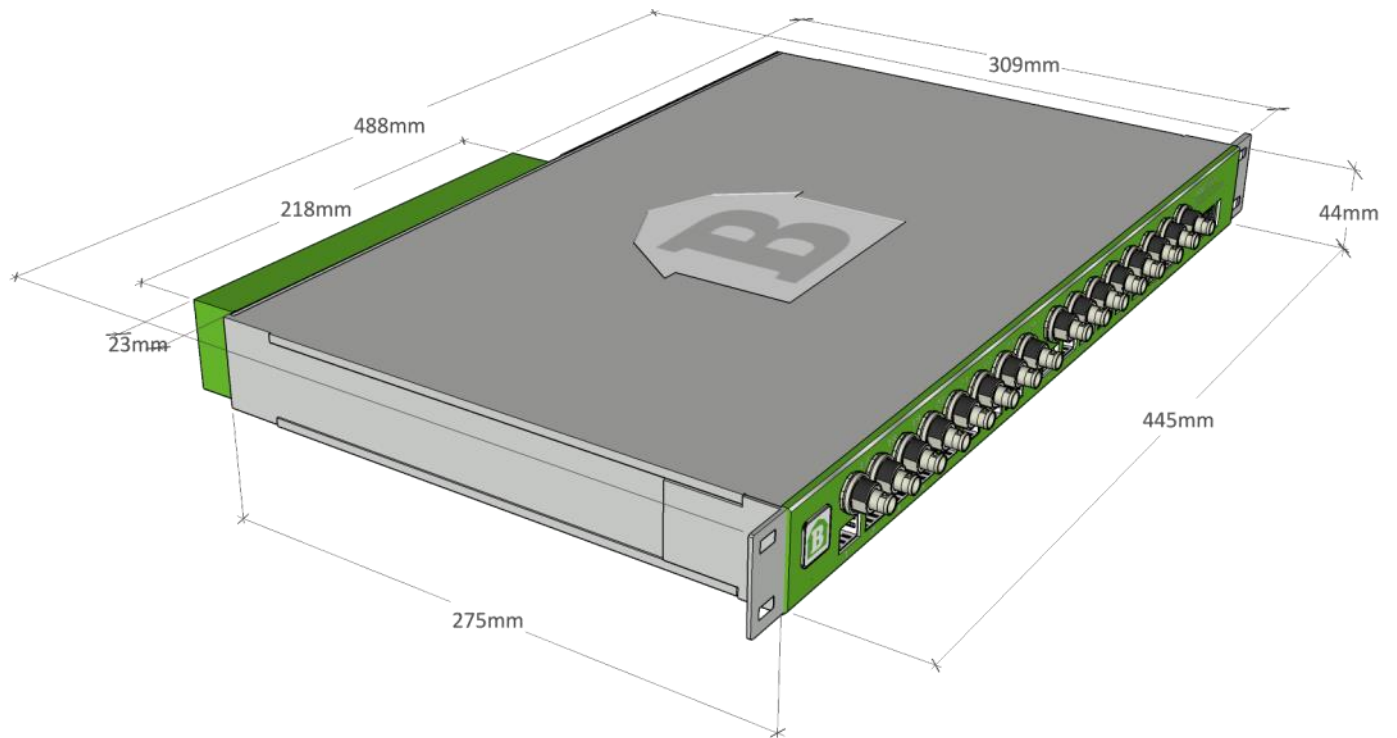

Extension Brackets (optional)

Mod nr: BT-EXT-EARS-5CM

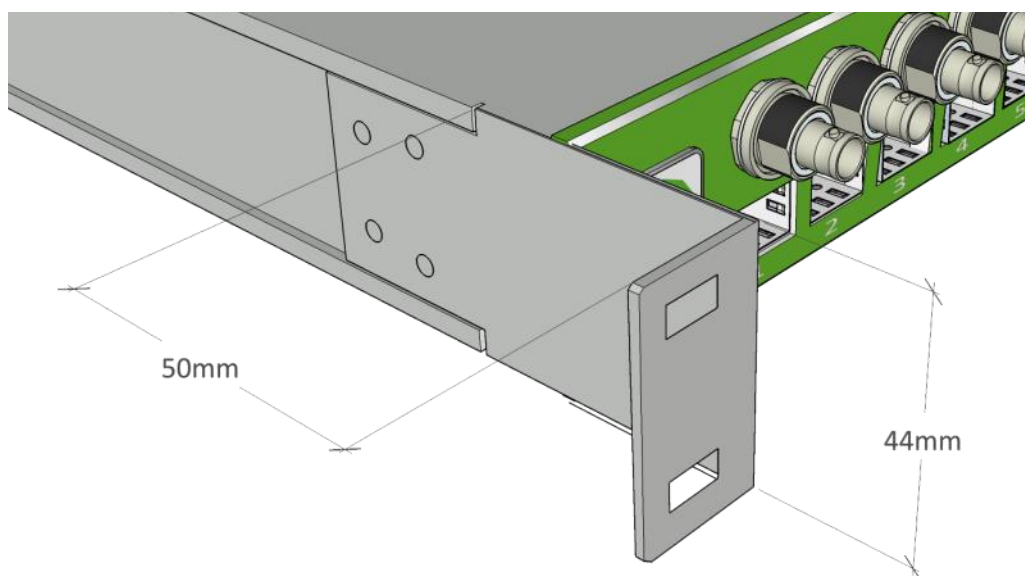

PSU-Tray (optional)

Mod nr: BT-TRAY-PSU

Barnfind PSU tray can be mounted at the rear end of the frame and can secure 2X standard PSU.

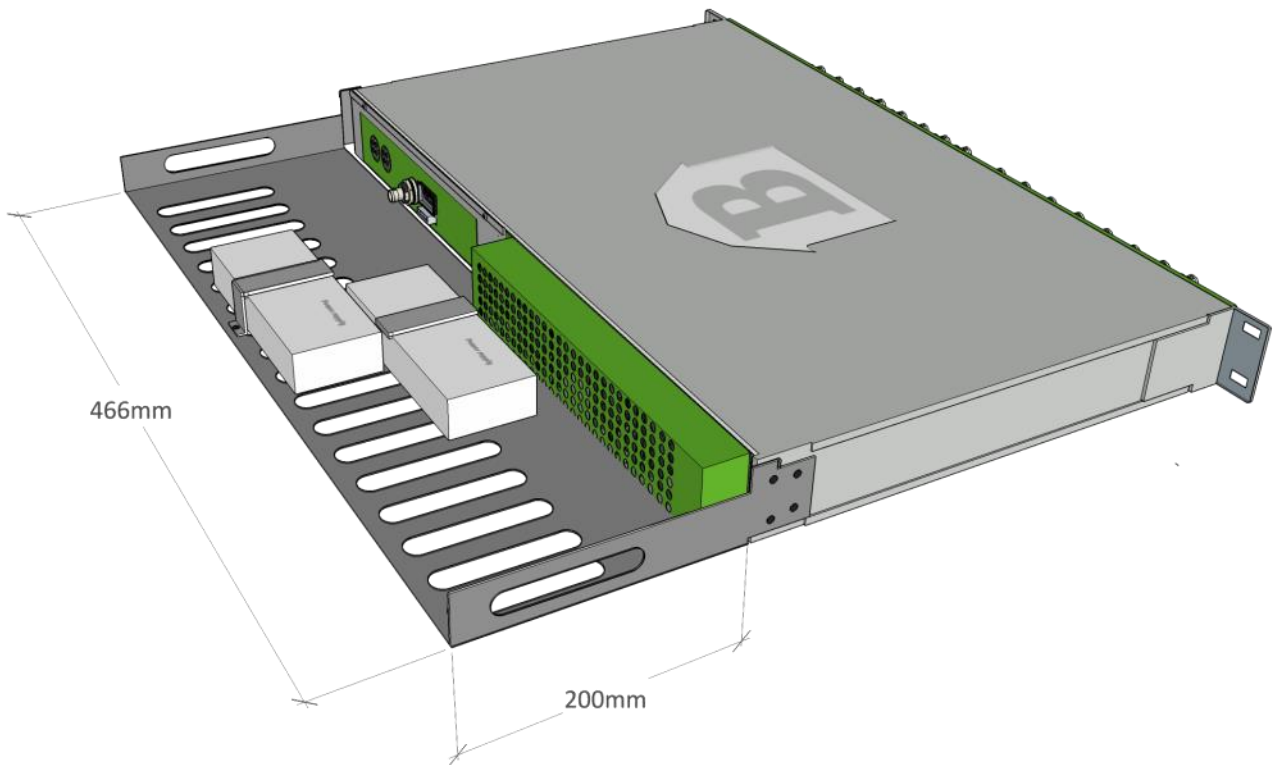
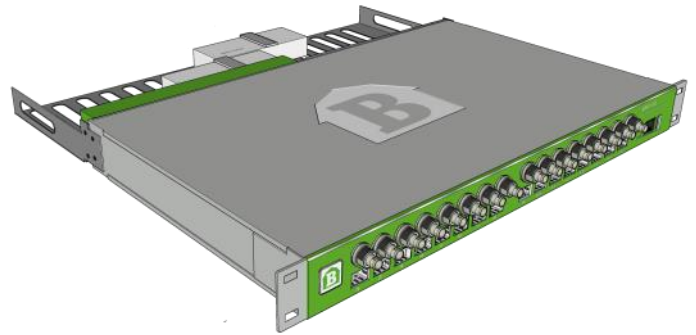

Turn-Brackets (standard)

The mounting brackets (rack ears) can be moved from front to rear side of the frame in order to turn the connectors and SFP direction.

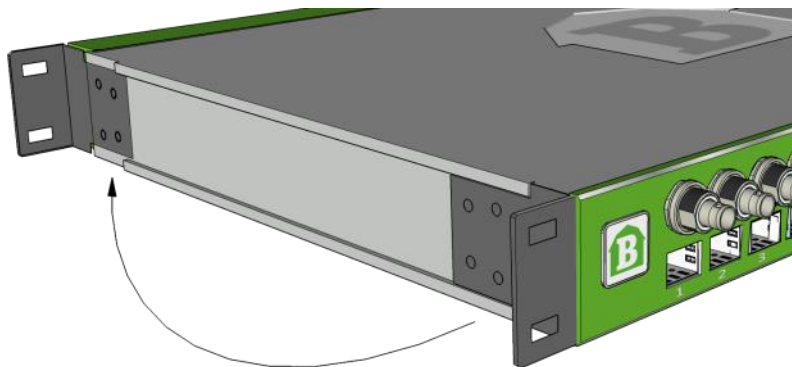

Technical Specifications

BNC Ports

- BNC port 75Ω switchable input or output
- SMPTE 259M, 292M, 372M, 424M, DVB-ASI, AES10 (MADI), AES3
- Automatic multirate reclocking of outputs 270Mbit/s - 3Gbit/s
- Automatic cable EQ (Belden 1694A) 270Mbit/s-250m, 1,5Gbit/s140m, 3Gbit/s-80m

SFP Ports

- Port for Small Form-Factor Pluggable (SFP), supports MSA-compliant (multi source agreement) transceivers
- Suitable for optical transceivers (singlemode/multimode), SFP media converters
- SMPTE 259M, 292M, 372M, 424M, 372M, DVB-ASI, AES10 (MADI), AES3
- Hot pluggable/swappable

Power Supply

- 12V DC power supply included
- PSU Input 100-240V AC 50/60Hz
- PSU Output 12V DC 8,5A
- redundant PSU optional

Physical Size

- 445mm x 280mm x 43,5mm (17.5" x 11.0" x 1.7")
- 3,8kg

Temperature

- Storage temperature -40°C - +70°C
- Operating temperature -20°C - +45°C
- Internal temperature depends on the selection of SFPs inserted. Some SFPs consume more power and are more sensitive to higher temperatures.
- ***Barnfind Technologies recommend to operate BTF1-xx frames in room temperature environment to ensure long lifetime and high performance.***

Power Consumption

- A BarnOne frame has an average power consumption of 28-30W without SFPs inserted. The total power consumption is frame plus SFPs.
- A standard optical SFP has an average power consumption of 1.5W. See data sheet for the specific SFP to calculate an accurate power consumption.



Power Consumption Example:

1x BTF1-02
8x BTSFP-CWDM-10-3GXX (see data sheet chapter 'SFPs')

W= Voltage (V) X Current (A)
0.2A x 3.3V = 0.66W

28 + (0.66x8) = 32.8 W_{tot}

BarnOne - the variations

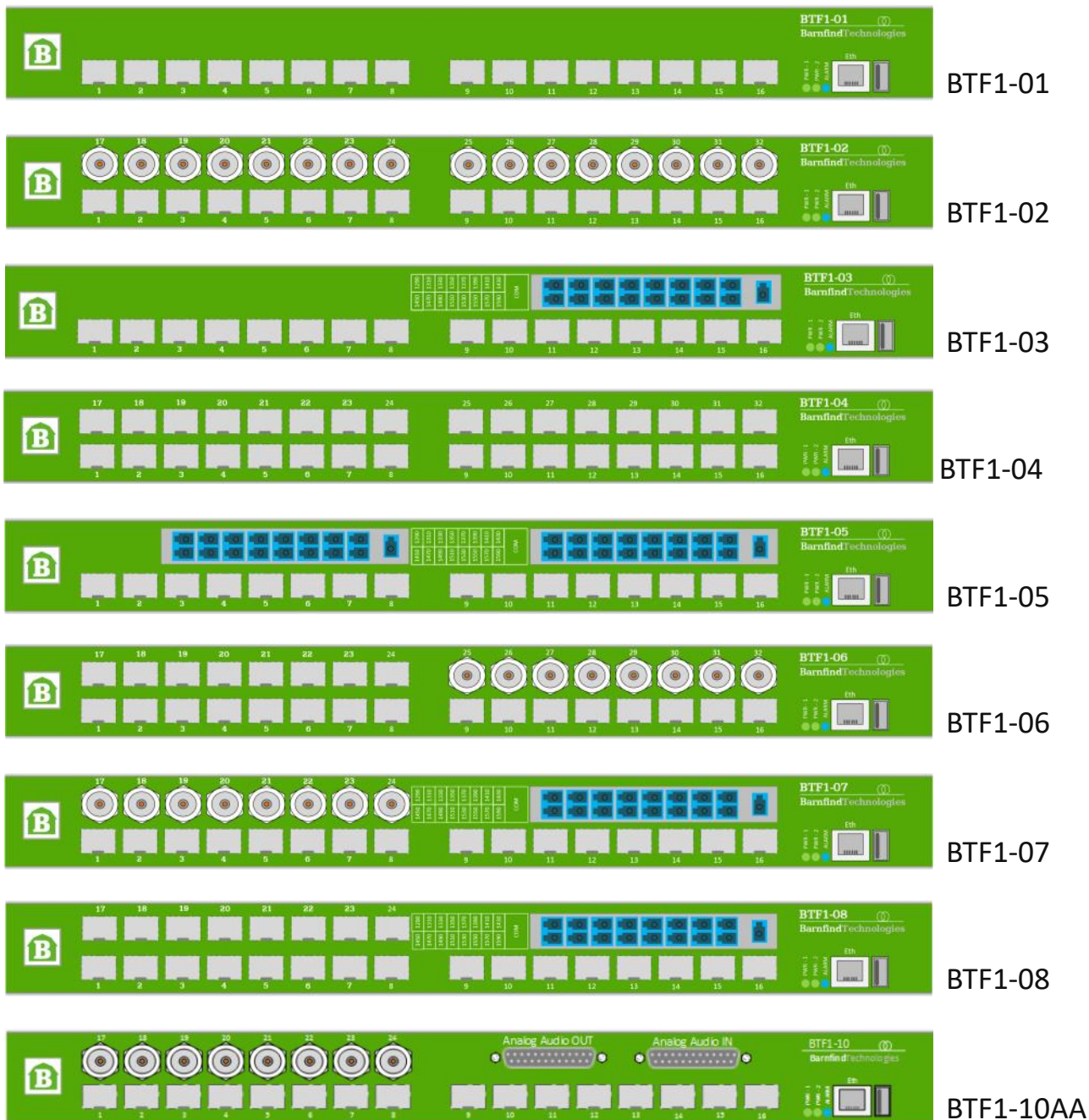

	BTF1-01	BTF1-02	BTF1-03	BTF1-04	BTF1-05	BTF1-06	BTF1-07	BTF1-08	BTF1-10AES	BTF1-10AA
SFP ports	16	16	16	32	16	24	16	24	16	16
Bi-directional BNC	-	16	-	-	-	8	8	-	8	8
CWDM channels	-	-	8/16	-	2x 8/16	-	8/16	8/16	-	-
AES3 I/O									8	
Analog Line I/O										8



Functionality Diagram

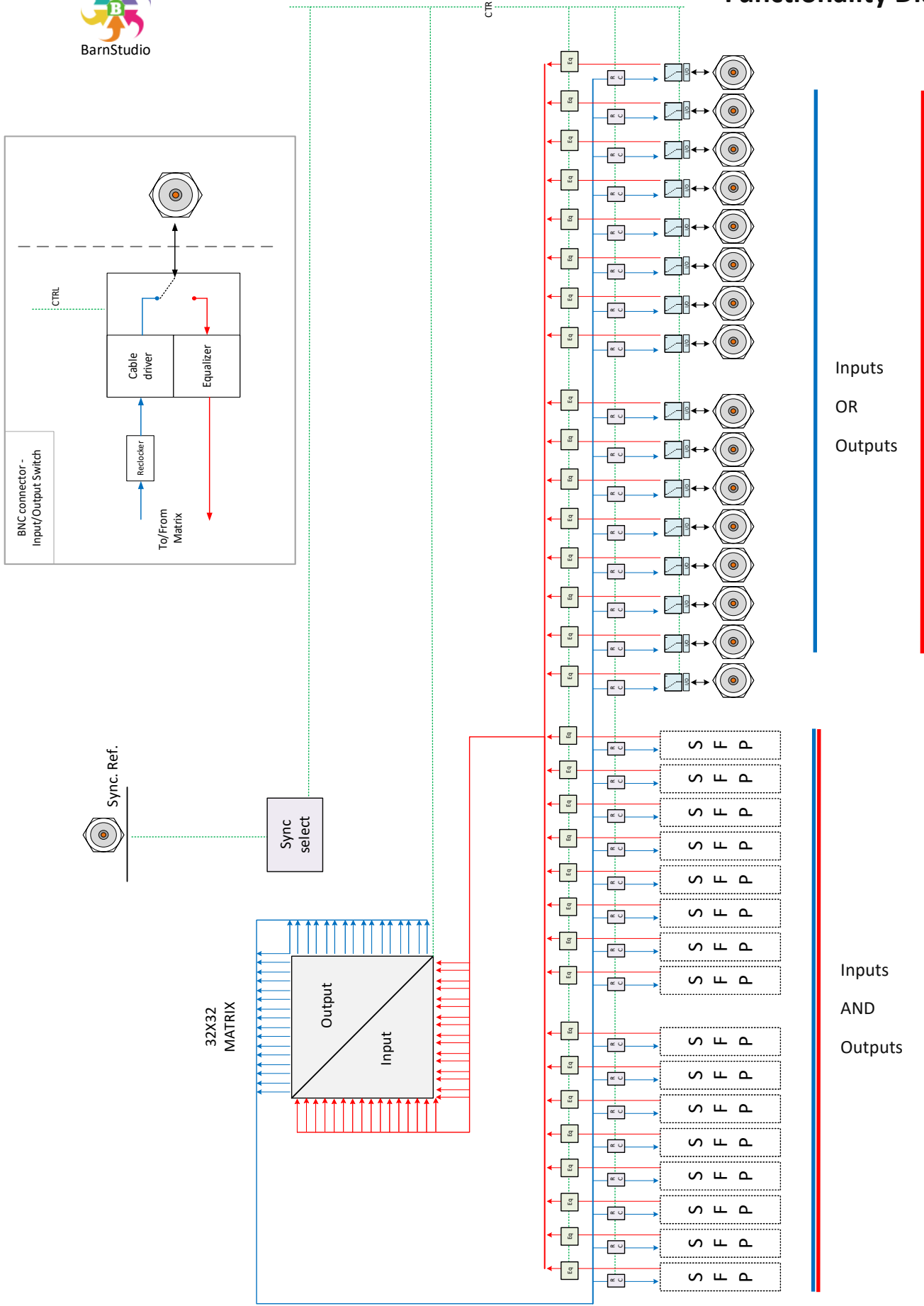

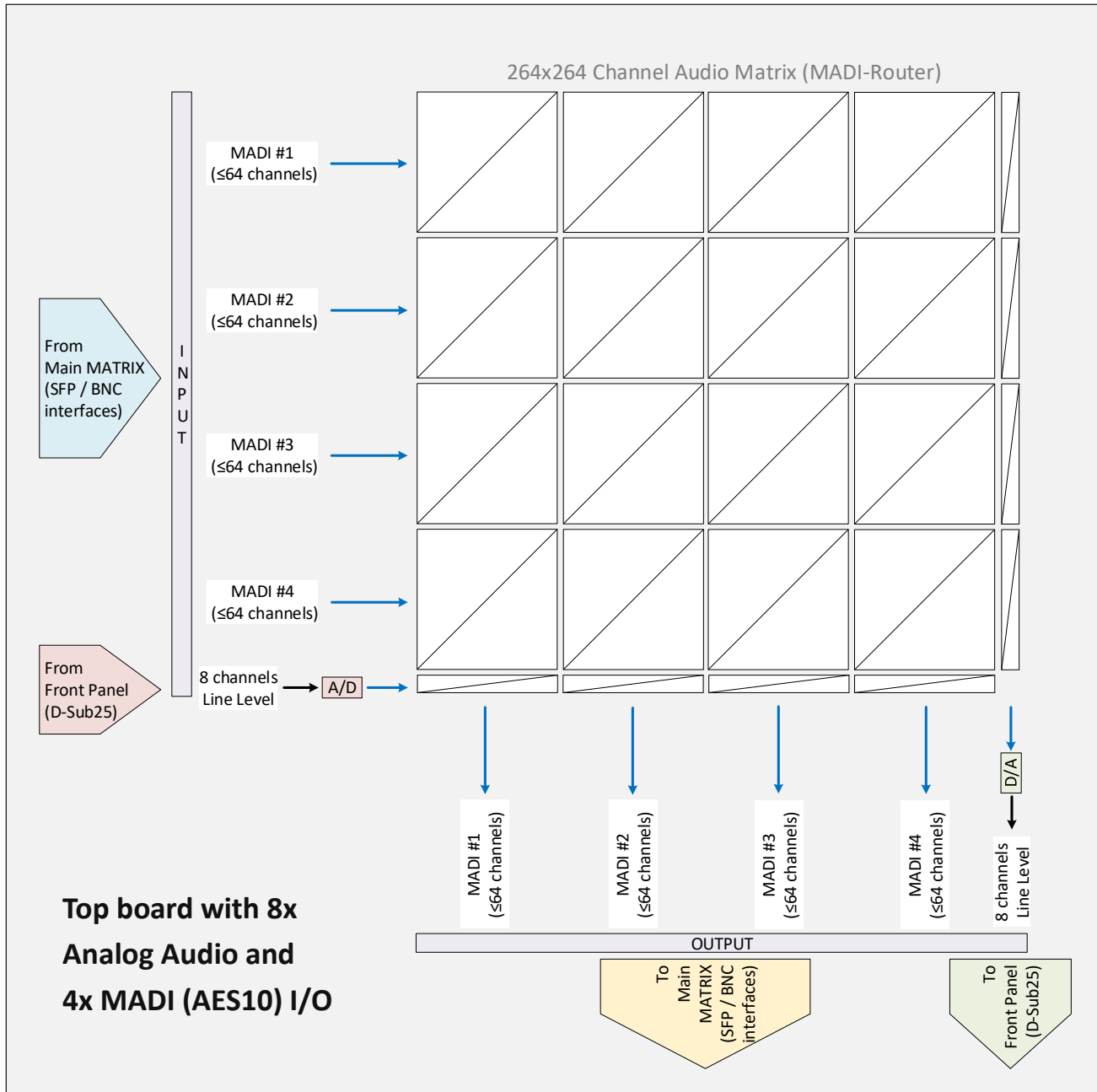

Technical Specifications

Internal ports	A/D converter
<ul style="list-style-type: none"> 4x internal MADI (AES10) I/O connected to main matrix Sample rate 44.1kHz/48kHz (1FS), 2FS and 4FS also supported Synchronisation to one of the MADI ports or internally 44.1kHz/48kHz (2FS and 4FS also supported) Single channel routing for all MADI analog I/O 	<ul style="list-style-type: none"> THD -115dB SNR -115dB unweighted THD+N -108dB
Analog ports <ul style="list-style-type: none"> 8x balanced analog line inputs (DB25), individually configurable +18dBu/+24dBu (default setting: +18dBu) 8x balanced analog line outputs (DB25), individually configurable +18dBu/+24dBu (default setting: +18dBu) 	D/A converter <ul style="list-style-type: none"> SNR -115dB THD+N -107dB

Pinout and Jumper settings BTF1-10AA analog line inputs and outputs

Pin-out for DB25 8 Channel
Balanced Connector
(TASCAM¹ pinout applies)

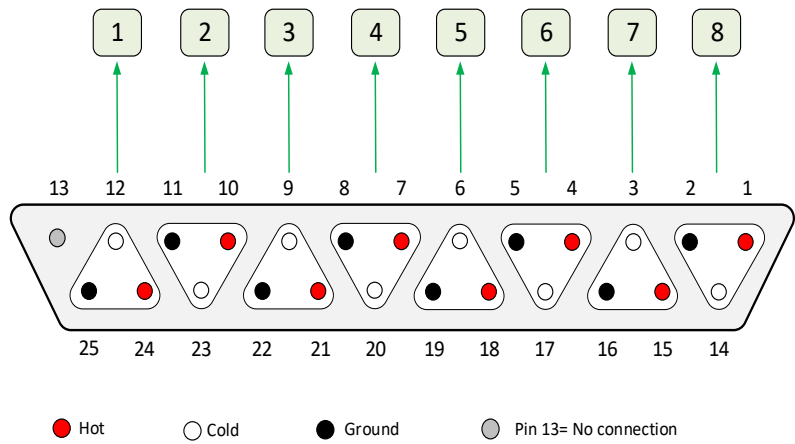

To change the jumper settings from +18dBu (default) to +24dBu, open the top lid of the BTF1-10AA frame with a Torx #15. The magnification in the pictures shows the settings for Input8 and Output8. You can change the settings for each input and output individually.

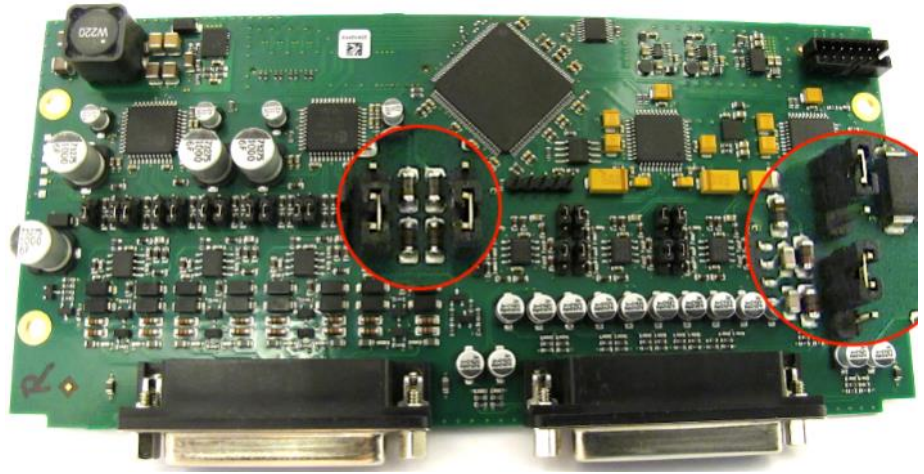

Jumper setting +18dBu (default)

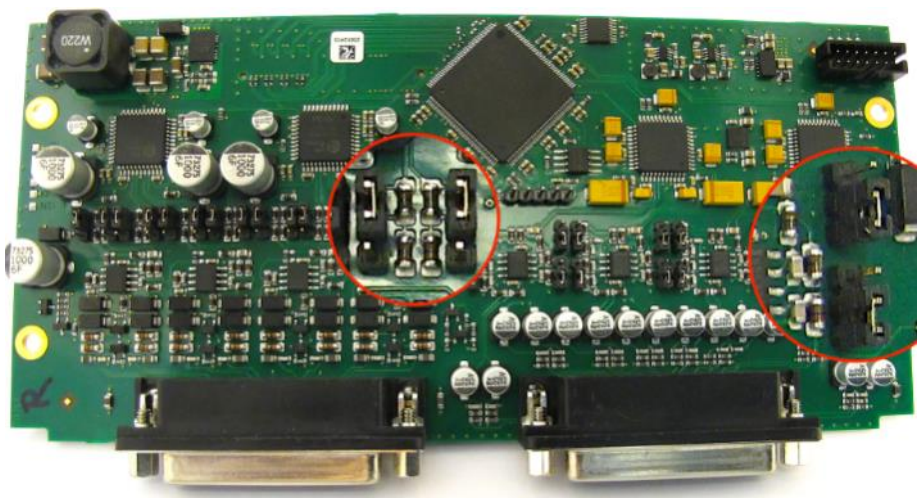

Jumper setting +24dBu

¹ TASCAM is a registered trademark of TEAC corporation



BarnOne

Order Number	Description
BTF1-01	16 SFP ports
BTF1-02	16 SFP ports and 16 BNC
BTF1-03-08	16 SFP ports and a 8 channel CWDM (de-)mux built in.
BTF1-03-16	16 SFP ports and a 16 channel CWDM (de-)mux built in.
BTF1-04	32 SFP ports
BTF1-05-08	16 SFP ports and 2X 8 channel CWDM (de-)mux built in.
BTF1-05-16	16 SFP ports and 2X 16 channel CWDM (de-)mux built in.
BTF1-06	24 SFP ports, 8 BNC
BTF1-07-08	16 SFP ports, 8 BNC and a 8 channel CWDM (de-)mux built in.
BTF1-07-16	16 SFP ports, 8 BNC and a 16 channel CWDM (de-)mux built in.
BTF1-08-08	24 SFP ports and a 8 or channel CWDM (de-)mux built in.
BTF1-08-16	24 SFP ports and a 16 or channel CWDM (de-)mux built in.
BTF1-10 AESemb	16 SFP ports, 8 BNC and 8 ch. AES3 digital audio embedding / de-embedding
BTF1-10 AA	16 SFP ports, 8 BNC and 8 ch. analog line level audio AD/DA conversion to/from MADI

All base frames are 1RU-19". Price includes single PSU, CPU and BarnStudio software for configuration and control.

BarnOne Accessories

Order Number	Description
BT-PSU-100-240AC	110-240VAC to 12V, 120W, Redundant PSU for BarnOne / BTF-Mini-16
BT-PSU-36-72DC	48VDC to 12V, 100W, Redundant PSU for BarnOne / BTF-Mini-16
BTF1-TRAY-PSU	Tray for PSU to be mounted on the rear side of BarnOne
BT-EXT-PAIR-5CM	Extention mounting brackets for BarnOne, 5cm deep. Price per pair
BT-FAN-BARNONE	Fan Cassette for BarnOne

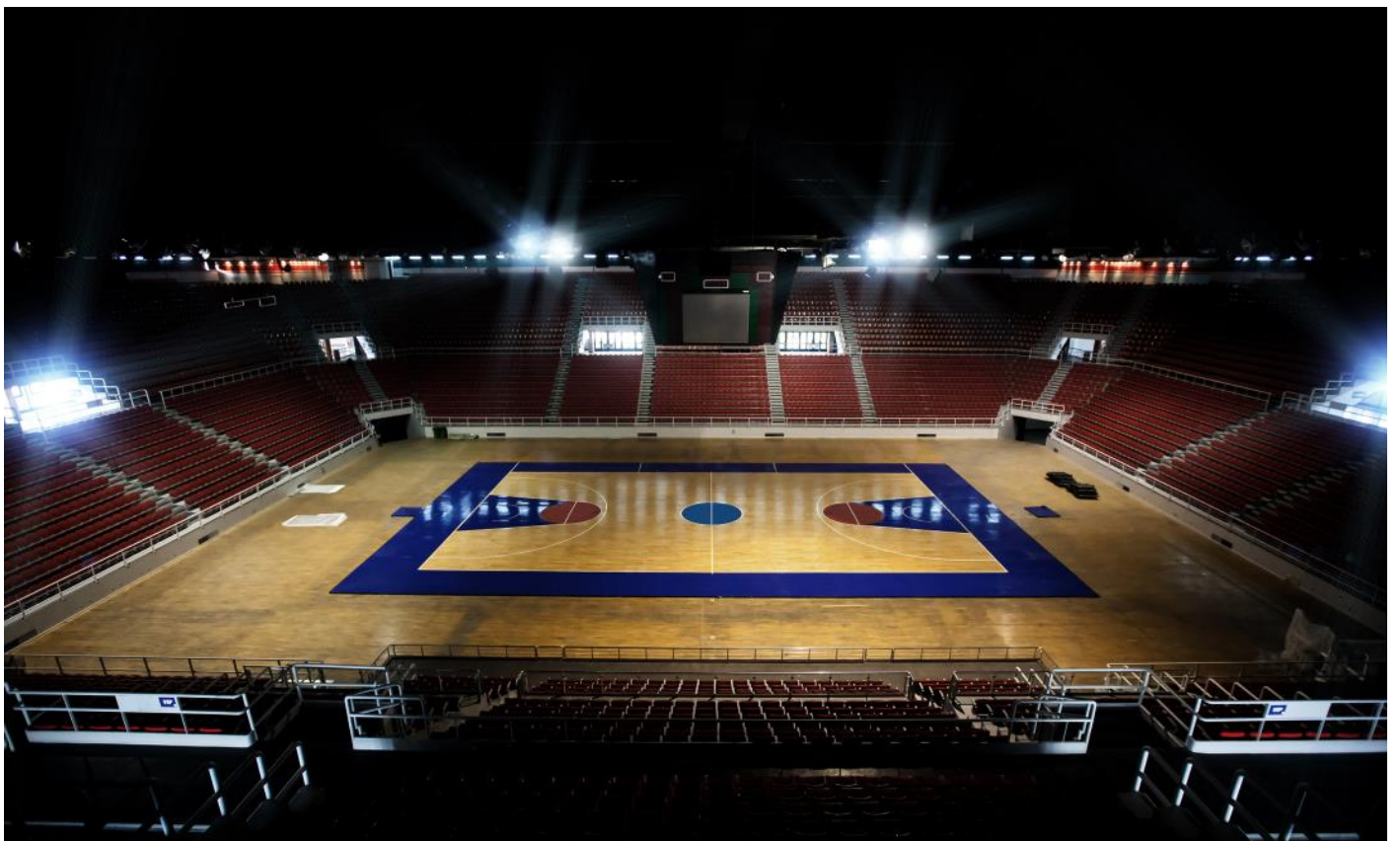



Stage Box Break-Out

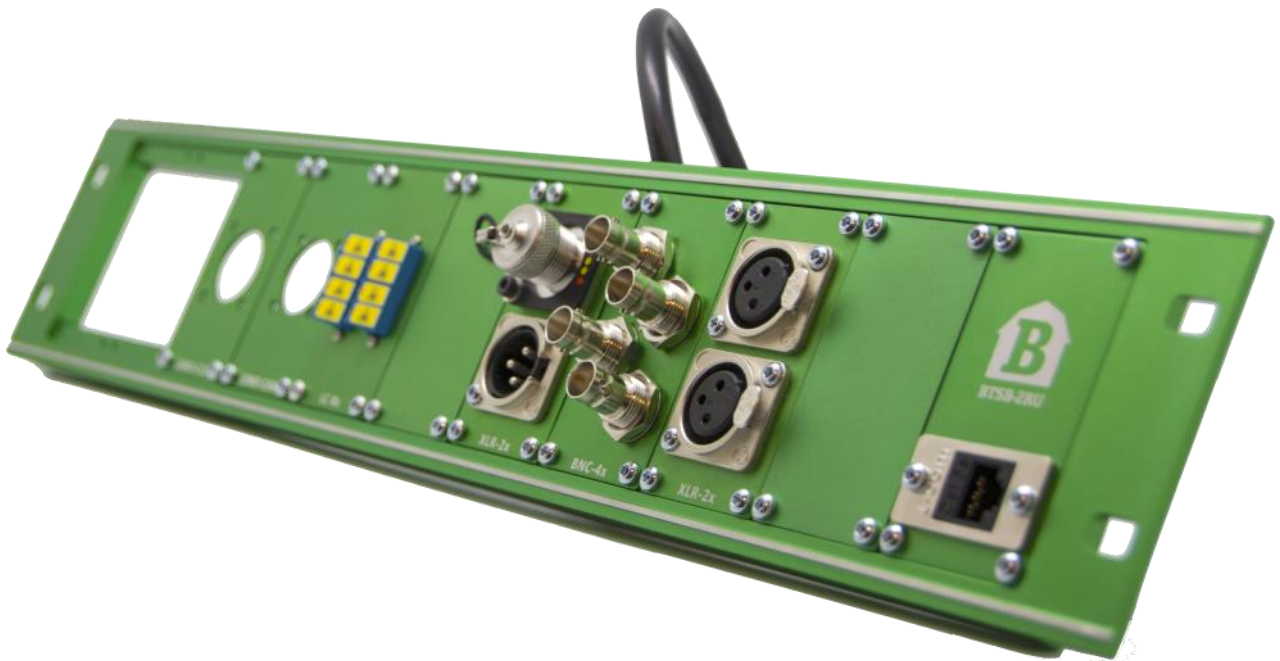

Module-based break-out panel

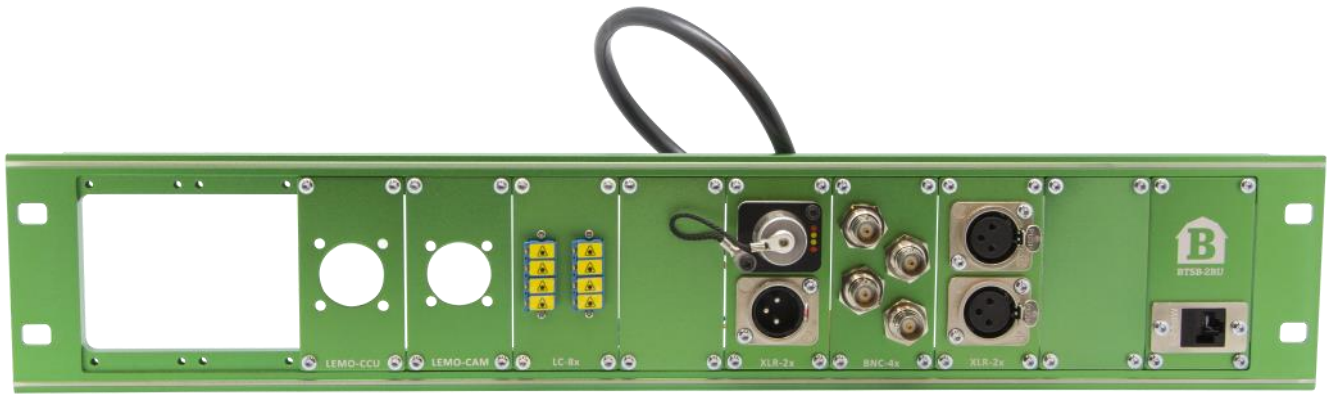

The Barnfind Stagebox break-out panel allows you to customize your own front panel based on the required connectors. The various selection of modules will be the connection points to one or more frames.

All modules are made of solid aluminium, with high performance connectors.

Note!

- The BTSB-BASE blind cover can be customized to fit any other connector outside the Barnfind selection.
- Cables between break-out panel and frames are not included.

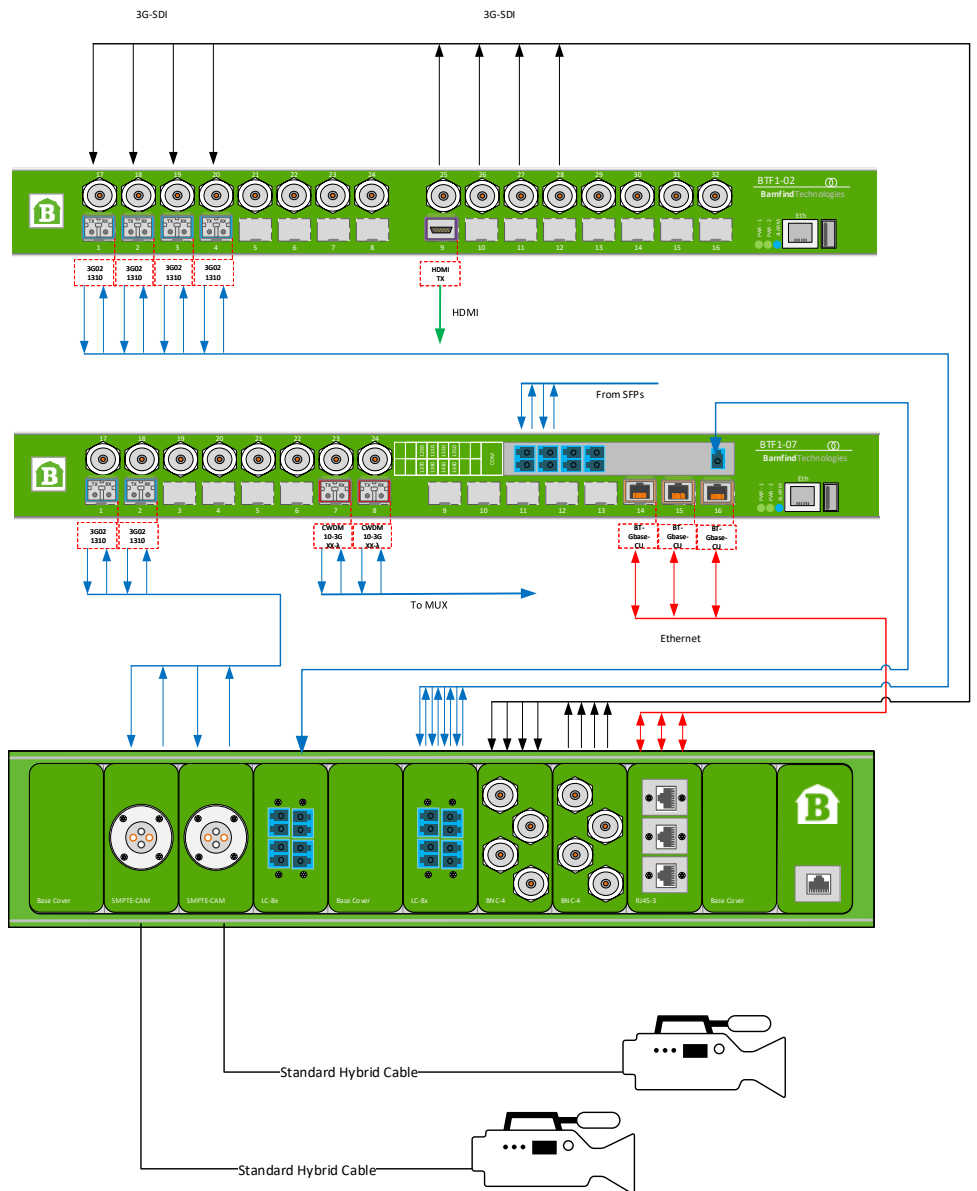

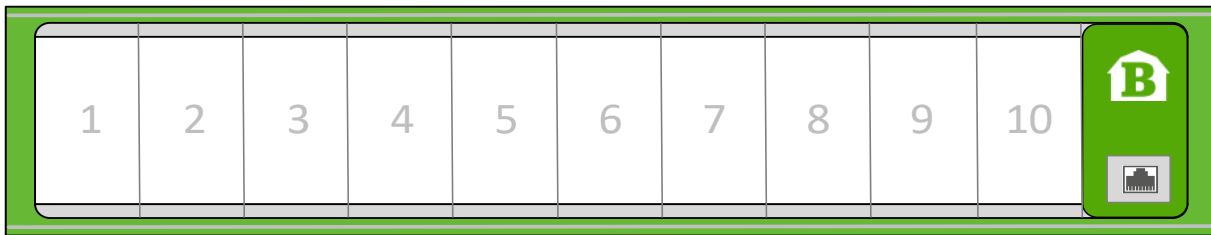

BTSB-2RU

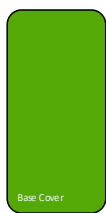

BTSB-BASE

Blind cover to fill up unused slots in BTSB-2RU.

Note, can also be used to customize for a special preferred connector.

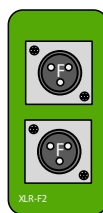

BTSB-XLR-F2x

Panel mounted XLR (female) connectors.

Also available without connector, suitable for Neutrik panel mount connectors.

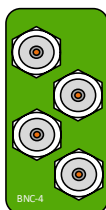

BTSB-BNC-4x

Panel mounted BNC connectors.

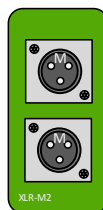

BTSB-XLR-M2x

Panel mounted XLR (male) connectors.

Also available without connector, suitable for Neutrik panel mount connectors.

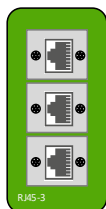

BTSB-RJ45-3x

Panel mounted RJ45 connectors.



BTSB-LEMO-CAM

Panel mounted LEMO FXW.3K SMPTE connector. Used as standard on many hybrid fiber cameras. **CAM connector (not included)***

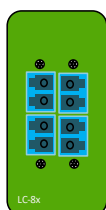

BTSB-LC-8x

Panel mounted LC connectors. Metal enclosure

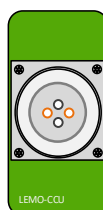

BTSB-LEMO-CCU

Panel mounted LEMO EDW.3K SMPTE connector. Used as standard on many hybrid fiber cameras. **CCU connector (not included)****



* LEMO 3K.93C SMPTE PANEL PLG, FXW with LC fibre



** LEMO 3K.93C SMPTE PANEL SKT, EDW with LC fibre





BarnMini Series



BTF-Mini-16

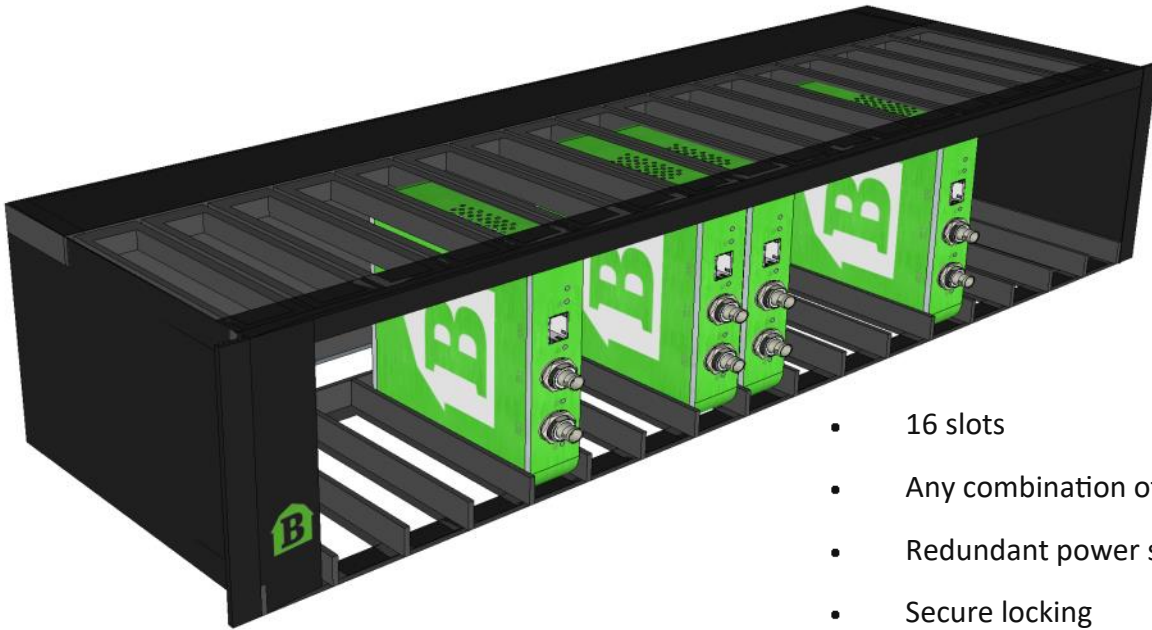

- 16 slots
- Any combination of BarnMinis
- Redundant power supply (optional)
- Secure locking

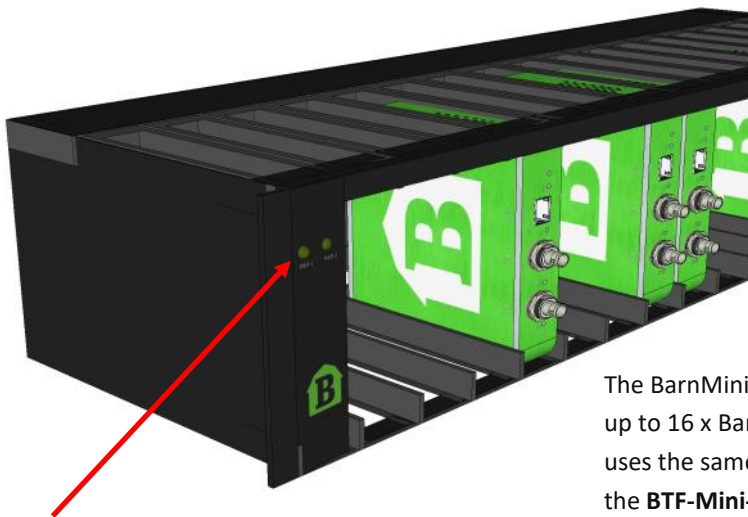

The **BTF-Mini-16** comes with 2 x LEDs in the front to indicate which PSU are connected

The BarnMini frame, **BTF-Mini-16**, is a housing with space for up to 16 x BarnMini modules of any kind. The BarnMini frame uses the same PSU as the BarnOne family, BTF1-XX. Note that the **BTF-Mini-16** comes with one standard single PSU (redundant PSU is optional mod nr: **BT-PSU-100-240AC**)



The **BarnMinis** are secured and released with thumb screws

BarnMini-01 - Coaxial to SFP Converter

This is the most popular BarnMini. It gives a unique platform to take in most video electrical signals and convert it to optical. The BarnMini-01 handles also SDTI signals from e.g. EVS. It comes with a second BNC that could be used for monitoring and other redundancy applications. Any optical SFPs can be used and even we can house a HDMI SFP for converting to HDMI or even coming in HDMI and convert back to electrical SDI. All outputs are re-clocked. BarnMini-01, can rightly claim to be the most flexible electrical to optical converter in the market.

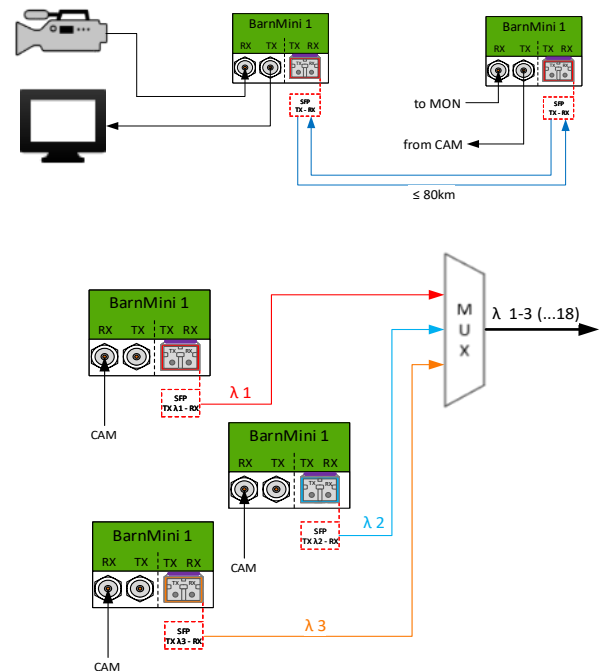

Technical Specifications

BNC ports

- 1x BNC port 75Ω TX
- 1x BNC port 75Ω RX
- SMPTE 259M, 292M, 372M, 424M, DVB-ASI, AES10 (MADI), AES3
- Automatic multirate reclocking of outputs 270Mbit/s - 3Gbit/s
- Automatic cable EQ (Belden 1694A) 270Mbit/s - 250m, 1,5Gbit/s - 140m, 3Gbit/s - 80m

SFP port

- Port for Small Form-Factor Pluggable (SFP), supports MSA-compliant (multi source agreement) transceivers
- Suitable for optical transceivers (singlemode/multimode), SFP media converters (HDMI, SDI, CVBS etc.)
- SMPTE 259M, 292M, 372M, 424M, 372M, DVB-ASI, AES10 (MADI), AES3
- Hot pluggable/swappable

Power Supply

- 12-24V DC power supply included
- redundant power supply available with BTF-Mini-16

Physical Size

- 92mm x 98mm x 22mm
- 200g

Model Name

- BM-01

SFP ↔ BNC

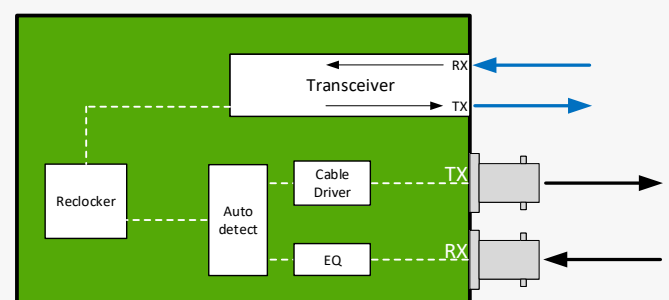

BarnMini-02 - SFP to SFP Converter

You can use any SFP from Barnfind or any other SFP as long as they are MSA compatible. BarnMini-02 is also popular due to the flexibility it brings. Imagine you need to go from multimode to single mode, taking an Ethernet signal into the fiber, using it as an affordable optical repeater etc. BarnMini-02 is our “Swiss army knife” and the great thing is that you can change your application by changing SFPs. As any of the BarnMini modules the BarnMini-02 can be used as a standalone box or in advanced systems with BarnOne or any 3rd party solution.

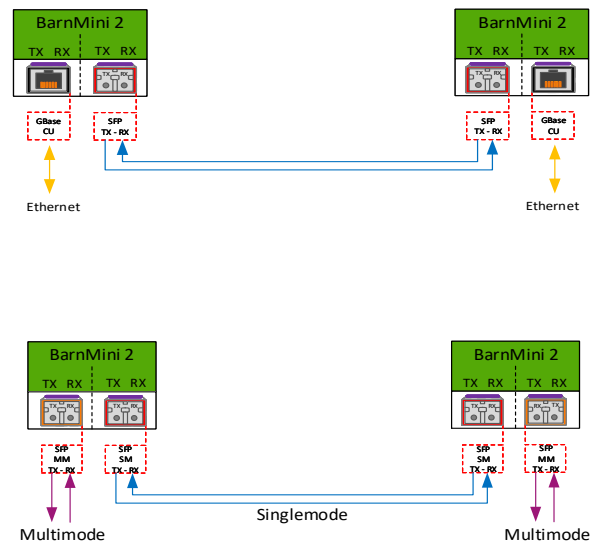

Technical Specifications

SFP ports

- 2x Port for Small Form-Factor Pluggable (SFP), supports MSA-compliant (multi source agreement) transceivers
- Suitable for optical transceivers (singlemode/multimode), SFP media converters (HDMI, Ethernet, SDI, CVBS etc.)
- SMPTE 259M, 292M, 372M, 424M, 372M, DVB-ASI, AES10 (MADI), AES3, Ethernet, proprietary protocols
- Hot pluggable/swappable

Power Supply

- 12-24V DC power supply included
- redundant power supply available with BTF-Mini-16

Physical Size

- 92mm x 98mm x 22mm
- 200g

Model Name

- BM-02

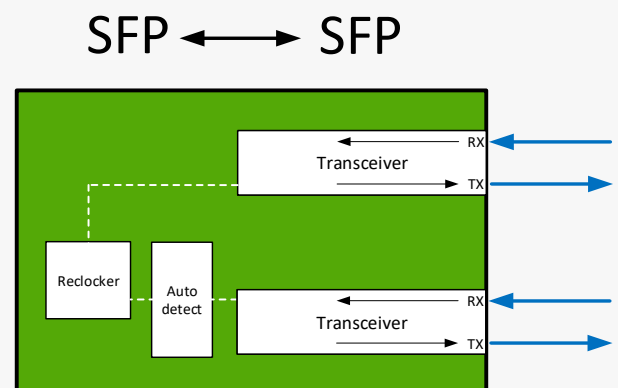

BarnMini-02 is equipped with 2x SFP cages, the SFP cages are connected TX to RX and RX to TX. The functionality will depend on the kind of SFPs which are inserted. A signal conversion does not take place inside BarnMini-02, it happens inside the SFP. The examples below only show a selection of typical user setups.

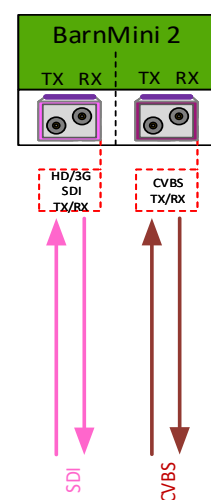
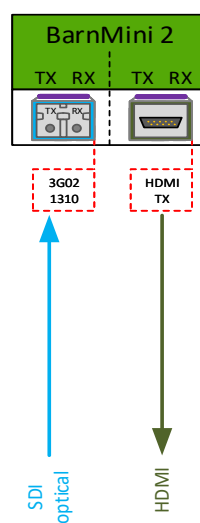
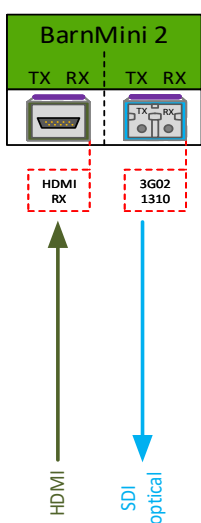
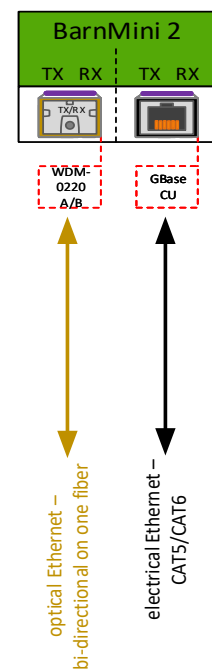
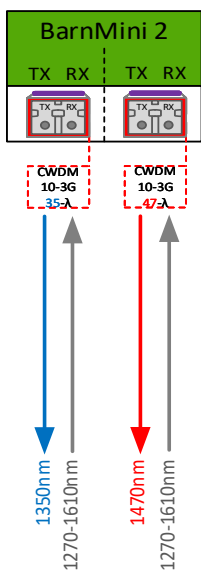

BarnMini-03 / BarnMini-04 - HDMI to SFP Converter

BarnMini-03

BarnMini-03 takes your HDMI signal to any optical fiber SFPs. This gives you a great flexibility how far and into what part of the value chain you wish to take your HDMI signal. If you have a mux to transport any other signals you can use one of our CWDM SFPs and directly transport it with other signals. The BarnMini-03 is very often used as a standalone unit for your monitor signals.

BarnMini-04

BarnMini-04 takes your optical SDI signal and convert it to a HDMI signal. This gives you a great flexibility in designing different monitoring solutions. The BarnMini-04 is very often used as a standalone unit. As any of our other BarnMini modules, the BarnMini-04 is also operational from 5V to 24V. As any of our other BarnMini modules, the BarnMini-04 brings unparalleled flexibility and it can serve several tasks.



Technical Specifications

HDMI port
<ul style="list-style-type: none"> • supports HDMI version 1.4
SFP port
<ul style="list-style-type: none"> • Port for Small Form-Factor Pluggable (SFP), supports MSA-compliant (multi source agreement) transceivers • Suitable for optical transceivers (singlemode/multimode), SFP media converters (SDI, CVBS etc.) • SMPTE 259M, 292M, 372M, 424M • Hot pluggable/swappable
Power Supply
<ul style="list-style-type: none"> • 12-24V DC power supply included • redundant power supply available with BTF-Mini-16
Physical Size
<ul style="list-style-type: none"> • 92mm x 98mm x 22mm • 200g
Model Name
<ul style="list-style-type: none"> • BM-03 / BM-04

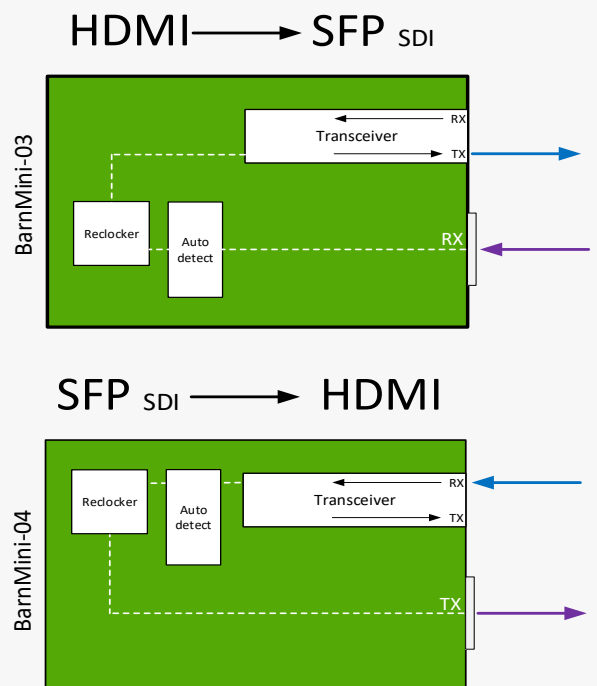

BarnMini-05 - GPIO and Serial Data (RS422/RS485) to Ethernet Converter

The BarnMini-05 is our most advanced BarnMini module. This is a compact way to combine serial data RS422/RS485, 4 x GPI and 4 x GPO, controllable via an Ethernet/SFP port. The unit can serve as an intelligent bridge between many third-party devices, for example transferring an RS422 signal or tally between two locations, or it can control an external optical changeover switch (BarnMini-06) in a redundancy setup. Triggers are easily set. BarnStudio, Barnfind's control software, can be used to configure and monitor BarnMini-05.



- 4x GPI
- 4x GPO
- RS422/485
- adjustable BAUD rate
- Supports TSL protocol for UMDs and Tally
- SFP port for optical or electrical interface (BTSFP-GBase-CU required for configuration with BarnStudio)

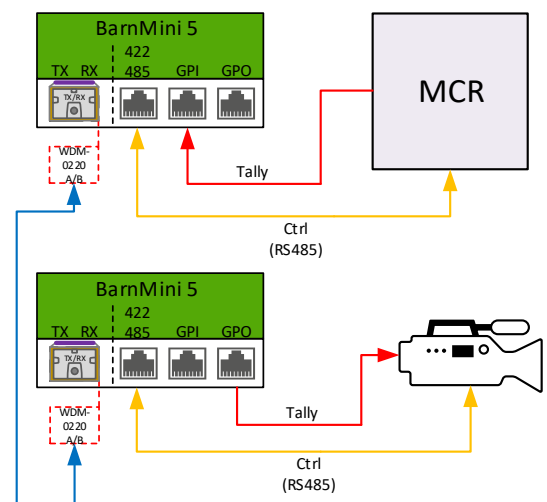

Technical Specifications

Serial Data Port <ul style="list-style-type: none"> • RJ45 connector • selectable RS422 or RS485 	Power Supply <ul style="list-style-type: none"> • 12-24V DC power supply included • redundant power supply available with BTF-Mini-16
GPIO ports <ul style="list-style-type: none"> • 2x RJ45 connector with 2x GPI and 2x GPO per connector • 4x GPI - optocoupled; common floating 5V reference; 240Ω resistor in series; connect to 0V reference to trigger • 4x GPO - Relays; max. 50V AC/DC; max 100mA 	Physical Size <ul style="list-style-type: none"> • 92mm x 98mm x 22mm • 200g
SFP port <ul style="list-style-type: none"> • Port for Small Form-Factor Pluggable (SFP), supports MSA-compliant (multi source agreement) transceivers • Suitable for optical transceivers (singlemode/multimode), SFP media converters (Ethernet) • Hot pluggable/swappable 	Model Name <ul style="list-style-type: none"> • BM-05

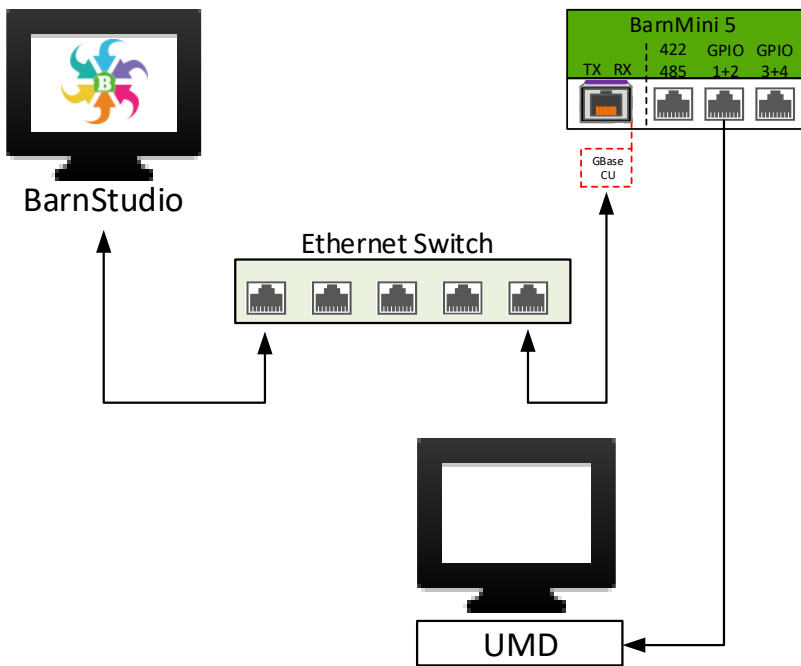

Use BarnStudio (free software) to access all the great functionalities and configurations in BarnMini-05 and frames in BarnOne family.

A complete and free version of BarnStudio can be downloaded from: <https://www.barnfind.no/downloads/>

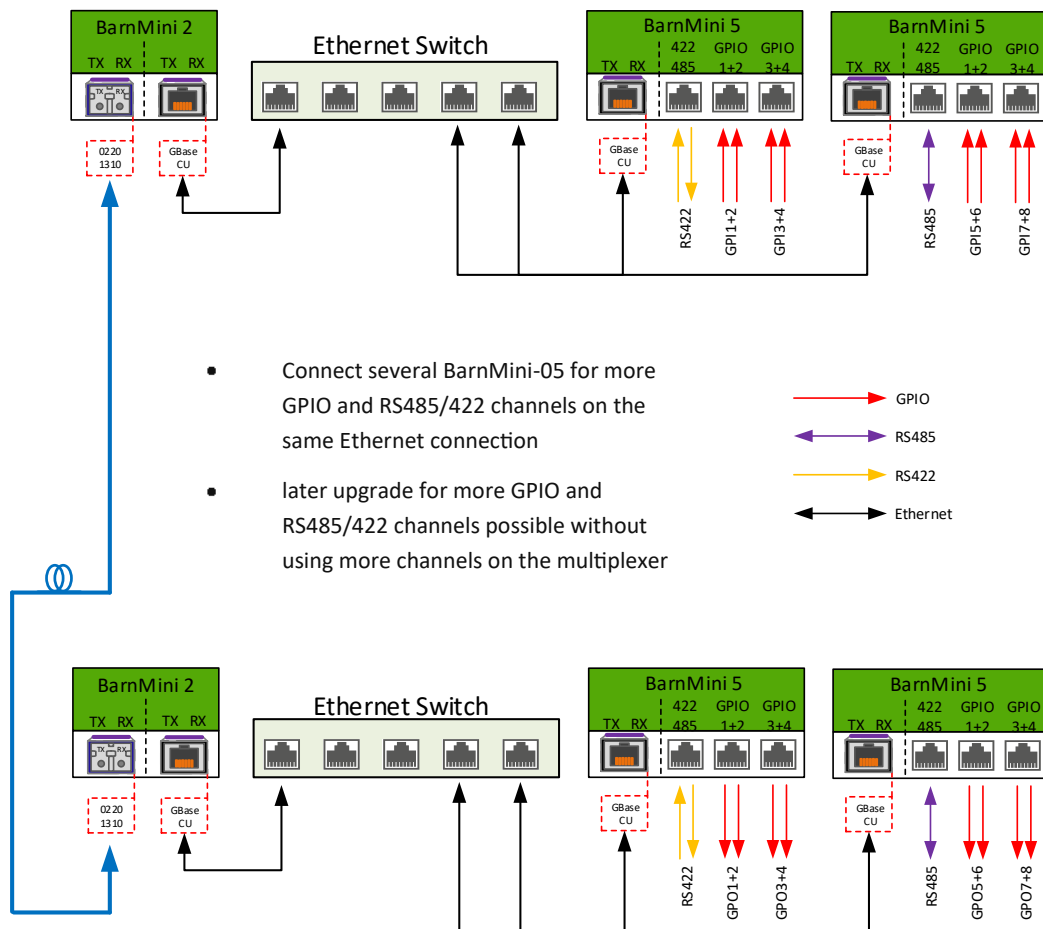

- Connect several BarnMini-05 for more GPIO and RS485/422 channels on the same Ethernet connection
- later upgrade for more GPIO and RS485/422 channels possible without using more channels on the multiplexer

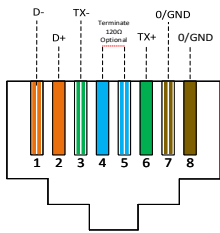

RS422/485 pinout (RJ45)

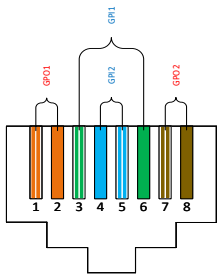

GPIO 1+2 pinout (RJ45)

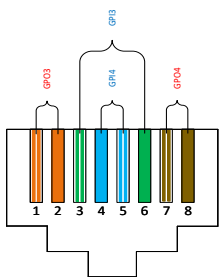

GPIO 3+4 pinout (RJ45)

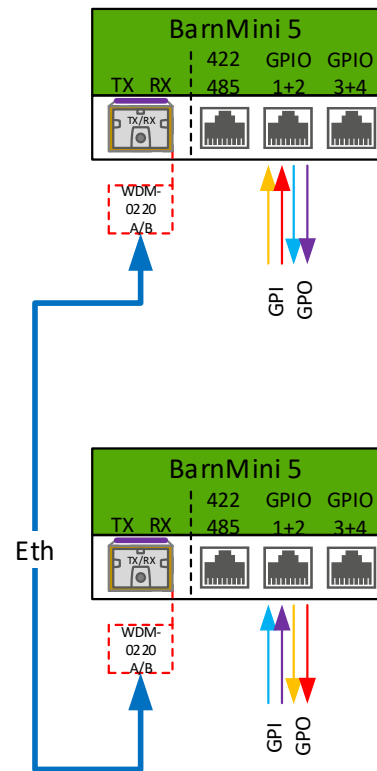

Automatic redundancy switching

BarnMini-05 can be configured to generate ping requests to a selected remote peer, e.g a computer, another BarnMini 05 or a BarnOne frame, and will expect an echo to validate the connection between them. If the requested echo is missing, the BarnMini-05 will activate one or more GPO connection.

In practical use, this can be used to toggle between main and redundant fiber lines.

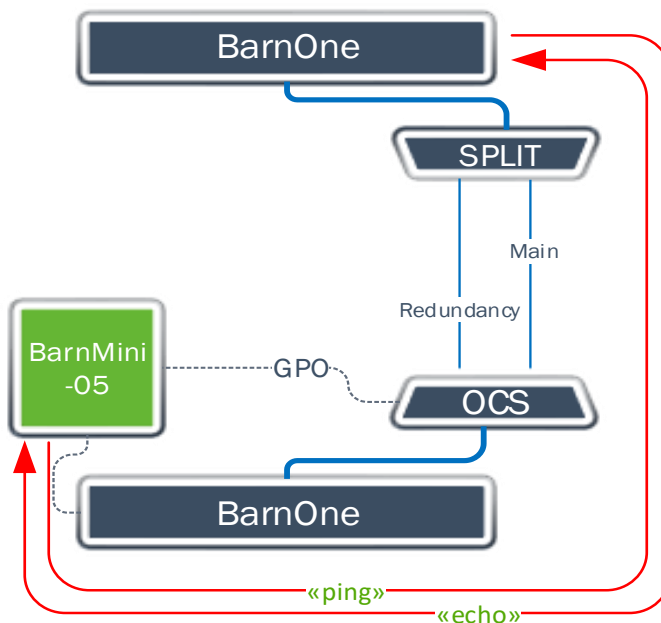

BarnMini-06 - Optical Change-Over

The BarnMini-06 is the optical changeover switch, which is very easy to integrate with the GPO devices that are found in many broadcast applications. A great advantage is the ability to provide its own power needed to drive the switch either as a stand alone or in the BarnMini frame with common PSU. The BarnMini-06 is often used in conjunction with the BarnMini-05. This is a great combination to create advanced signal redundancy solutions.



**example*

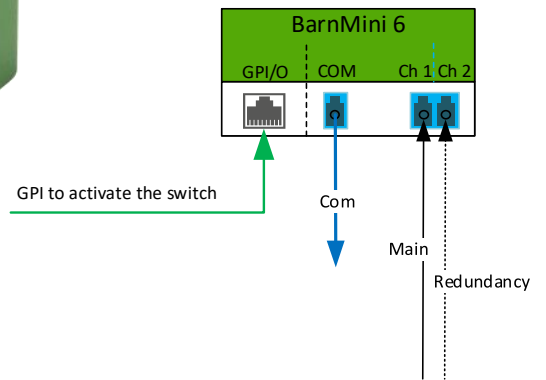

Technical Specifications

Optical Ports <ul style="list-style-type: none"> • LC/PC connectors • Operating Wavelength 850-1620nm • Fiber type Single Mode • Insertion Loss <1,2dB • Wavelength dependant loss <0,3dB • Polarisation dependant loss 0,05dB • Crosstalk >35dB • Return loss >35dB 	GPI port <ul style="list-style-type: none"> • RJ45 connector with 4x GPI wired parallel, non latching
Optical Switch <ul style="list-style-type: none"> • Switching time <10ms (typically 4ms) • Max. switching cycles 10.000 	Power Supply <ul style="list-style-type: none"> • 12-24V DC power supply included • redundant power supply available with BTF-Mini-16
	Physical Size <ul style="list-style-type: none"> • 92mm x 98mm x 22mm • 200g
	Model Name <ul style="list-style-type: none"> • BM-06

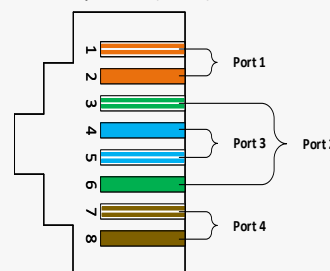

a contact closure on any of the GPI ports will trigger the switch

BarnMini-07 - Optical Multiplexer

The BarnMini-07 is a 4-channel CWDM mux that can be used e.g. for transportation of 3G-quad over different mediums. This is a compact, efficient and affordable mux. It fits into the BarnMini BTF-Mini-16 frame. The BarnMini-07 saves you both rack space and money. For growing up to 8 channels, we can offer optional upgrade.

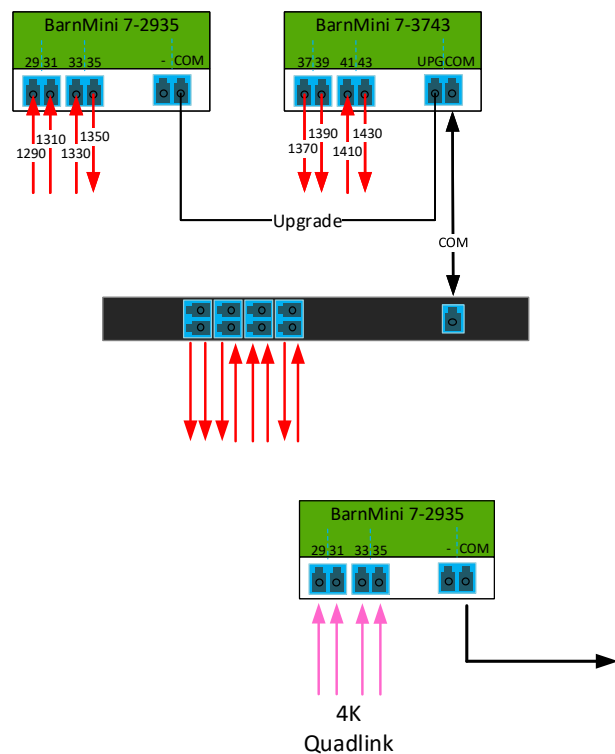
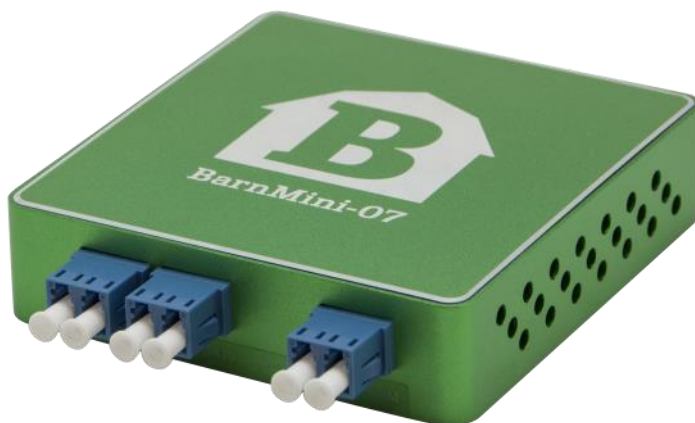

Technical Specifications

Optical Ports

- LC/PC connectors
- Center Wavelength BM-07 2935 1290, 1310, 1330, 1350nm
- Center Wavelength BM-07 3743 1370, 1390, 1410, 1430nm
- Channel clear passband +/- 6,5nm
- Insertion Loss <1,2dB
- Passband ripple <0,5 dB
- Adjacent Channel Isolation >30dB
- Non-Adjacent Channel Isolation >45dB
- Polarisation dependant loss 0,02dB
- Directivity >50dB
- Return loss >45dB
- Polarisation Mode Dispersion <0,2ps

Physical Size

- 92mm x 98mm x 22mm
- 200g

Model Name

- BM-07 2935 / BM-07 3743

BarnMini-07		
	mod 2935	mod 3943
Wavelength	1290	
	1310	
	1330	
	1350	
	Upgrade	1370
	1390	
	1410	
	1430	

BarnMini-08 - Optical Splitter

This BarnMini unit comes in two optical splitter versions; either as BarnMini-08-1:2 or BarnMini-08-1:4. It is a great supplement in smaller BarnMini systems, but can also be used in more advanced BarnOne configurations. As with any of our other BarnMini modules; the BarnMini-08 has rock solid mechanics and technology and it can work in harsh environments.

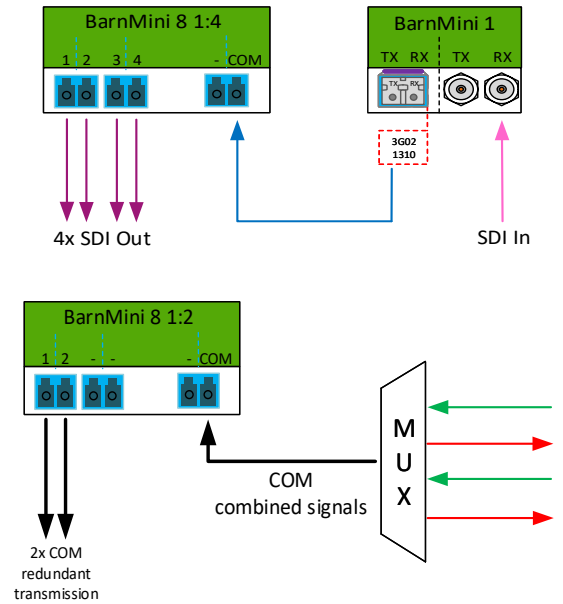

Technical Specifications

Optical Ports

- LC/PC connectors
- Insertion Loss <1,2dB + 3 or 6, see figures
- Adjacent Channel Isolation >35dB
- Non-Adjacent Channel Isolation >45dB
- Polarisation dependant loss <0,10dB

Physical Size

- 92mm x 98mm x 22mm
- 200g

Model Name

- BM-08 1:2 / BM-08 1:4

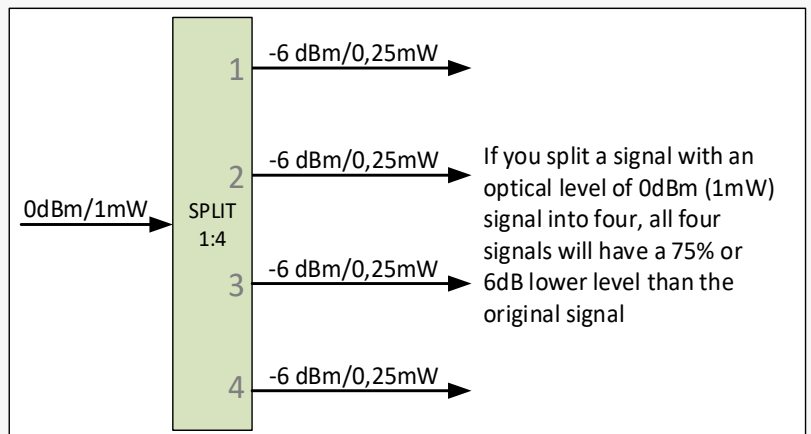
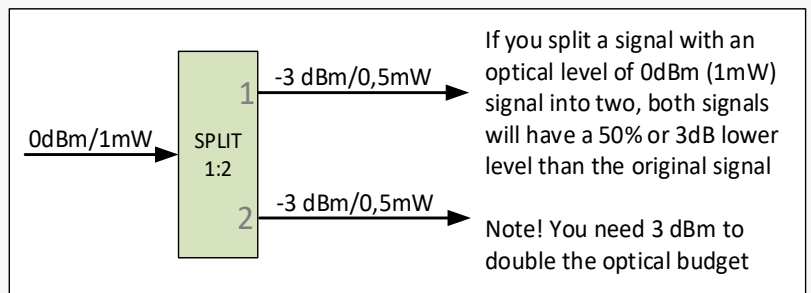

BarnMini-11 - Coaxial to SFP/SFP+ Converter 12G

The BarnMini-11 is the big brother to the popular BarnMini-01 solution that delivers simple and reliable point-to-point digital extension. BarnMini-11 offers support for up to 12Gbit/s bandwidth. It can handle 12G, 10G, 6G and any other video/data format with a lower data rate than 12Gbit/s. BarnMini-11 is equipped with a re-clocker. And as any other BarnMini module it is flexible and with comprehensive video specifications.

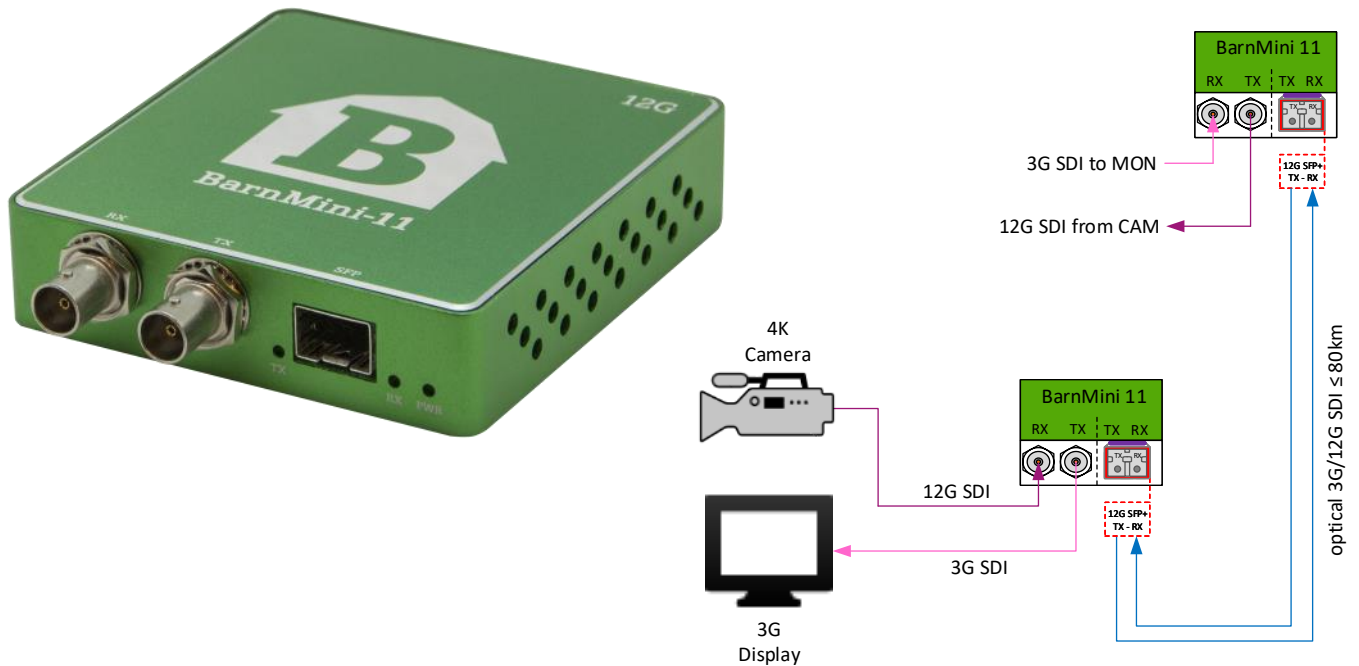

Technical Specifications

BNC ports <ul style="list-style-type: none"> • 1x BNC port 75Ω TX • 1x BNC port 75Ω RX • SMPTE 259M, 292M, 372M, 424M, ST-2081, ST-2082, DVB-ASI, AES10 (MADI), AES3 • Automatic multirate reclocking of outputs 270Mbit/s - 12Gbit/s • Automatic cable EQ (Belden 1694A) 270Mbit/s - 250m, 1,5Gbit/s - 140m, 3Gbit/s - 80m, 12Gbit/s - 60m 	Power Supply <ul style="list-style-type: none"> • 12-24V DC power supply included • redundant power supply available with BTF-Mini-16
SFP/SFP+ port <ul style="list-style-type: none"> • Port for Small Form-Factor Pluggable Plus (SFP+) and SFP, supports MSA-compliant (multi source agreement) transceivers • Suitable for optical transceivers (singlemode/multimode), SFP media converters (HDMI, SMPTE 259M, 292M, 372M, 424M, 372M, ST-2081, ST-2082, DVB-ASI, AES10 (MADI), AES3 • Hot pluggable/swappable 	Physical Size <ul style="list-style-type: none"> • 92mm x 98mm x 22mm • 200g Model Name <ul style="list-style-type: none"> • BM-11

SFP+ ↔ BNC

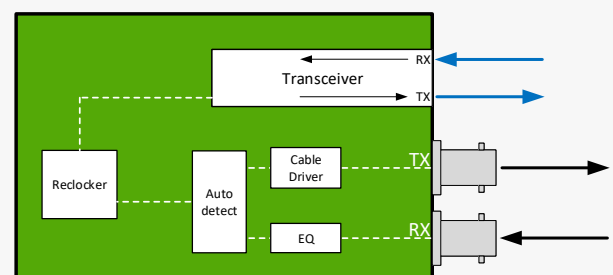

BarnMini-12 - SFP+ to SFP+ Converter 12G

BarnMini-12 supports data rates up to 12Gbit/s. It can handle 12G, 10G, 6G and any other video format with a lower data rate than 12Gbit/s. It is equipped with a re-clocker. As any BarnMini module it is available as a standalone unit with a separate PSU or mounted into the BarnMini BTF-Mini-16 frame that houses any combination of 16 x BarnMini modules with a common PSU.



Technical Specifications

SFP/SFP+ ports

- 2x Port for Small Form-Factor Pluggable Plus (SFP+) and SFP, supports MSA-compliant (multi source agreement) transceivers
- Suitable for optical transceivers (singlemode/multimode), SFP/SFP+ media converters (HDMI, Ethernet, SDI, CVBS etc.)
- SMPTE 259M, 292M, 372M, 424M, 372M, ST-2081, ST-2082, DVB-ASI, AES10 (MADI), AES3, Ethernet, proprietary protocols
- Hot pluggable/swappable

Power Supply

- 12-24V DC power supply included
- redundant power supply available with BTF-Mini-16

Physical Size



- 92mm x 98mm x 22mm
- 200g

Model Name

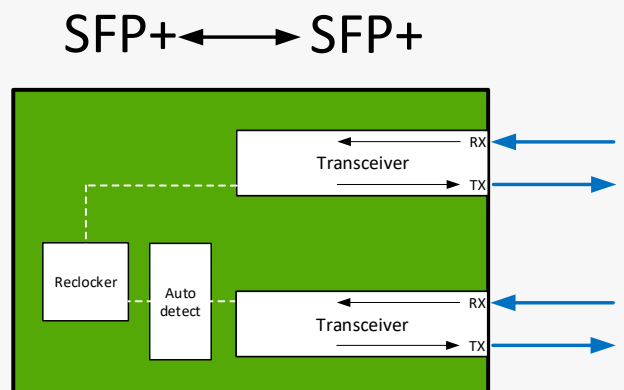
- BM-12



BarnMini

Order Number	Description
BarnMini-01	BNC TX/RX, SFP port for transceiver (TX/RX), incl. PSU.
BarnMini-02	2xSFP port for transceiver (TX/RX), incl. PSU.
BarnMini-03	HDMI-SFP, HDMI RX, SFP port for transmitter (TX), incl. PSU.
BarnMini-04	SFP-HDMI, HDMI TX, SFP port for receiver (RX), incl. PSU.
BarnMini-05	4x GPI and 4x GPO through ethernet / fiber, incl. PSU.
BarnMini-06	Optical Change Over (OCS) GPI controlled
BarnMini-07-2935	Passive 4 channel CWDM Mux/Demux in BarnMini Housing (1290-1350nm)
BarnMini-07-3743	Passive 4 channel CWDM Mux/Demux in BarnMini Housing (1370-1430nm)+Upgrade Port for BarnMini-07-2935
BarnMini-08-1:2	Passive distribution of optical signals 1:2 out
BarnMini-08-1:4	Passive distribution of optical signals 1:4 out
BarnMini-11	 BNC TX/RX, SFP+ port for transceiver (TX/RX), incl. PSU. 12G
BarnMini-12	 2xSFP+ port for transceiver (TX/RX), incl. PSU. 12G
BTF-Mini-16	2.5RU frame for housing of up to 16 BarnMinis, incl. PSU.

BarnMini Accessories

Order Number	Description
BT-Mini-PSU	Spare PSU for BarnMini series (stand-alone)
BT-PSU-100-240AC	110~240VAC to 12V, 120W, Redundant PSU for BarnOne / BTF-Mini-16
BT-PSU-36-72DC	48VDC to 12V, 100W, Redundant PSU for BarnOne / BTF-Mini-16





LGX Series

Passive Optical Products

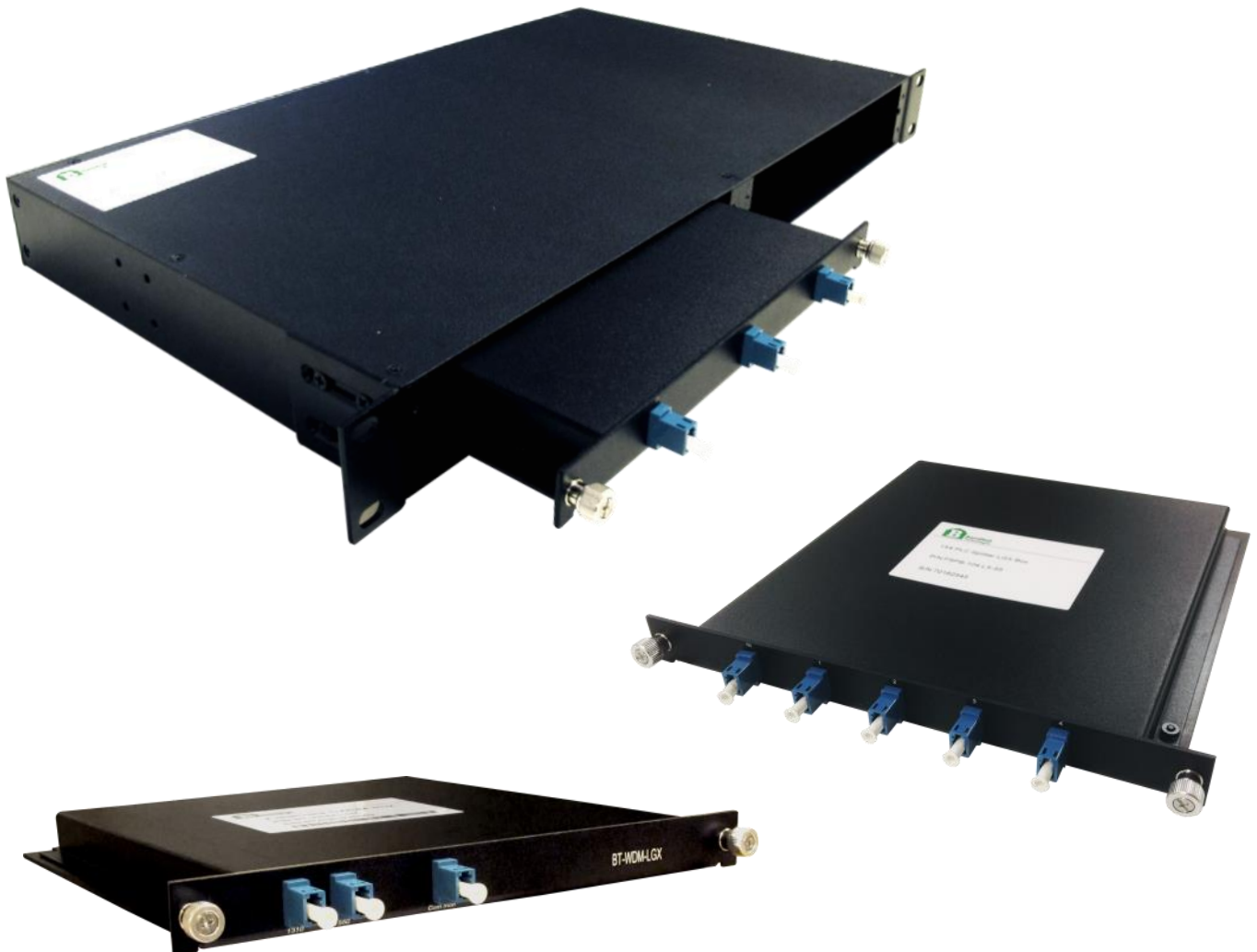

BT-HOUS-LGX-1RU

BT-HOUS-LGX-1RU is a 1 rack unit housing for passive optical products. It can accommodate up to 4 pcs of modules, eg. CWDM multiplexers, splitters and optical changeover switches. Each module is secured with a thumbscrew for easy and quick replacement.

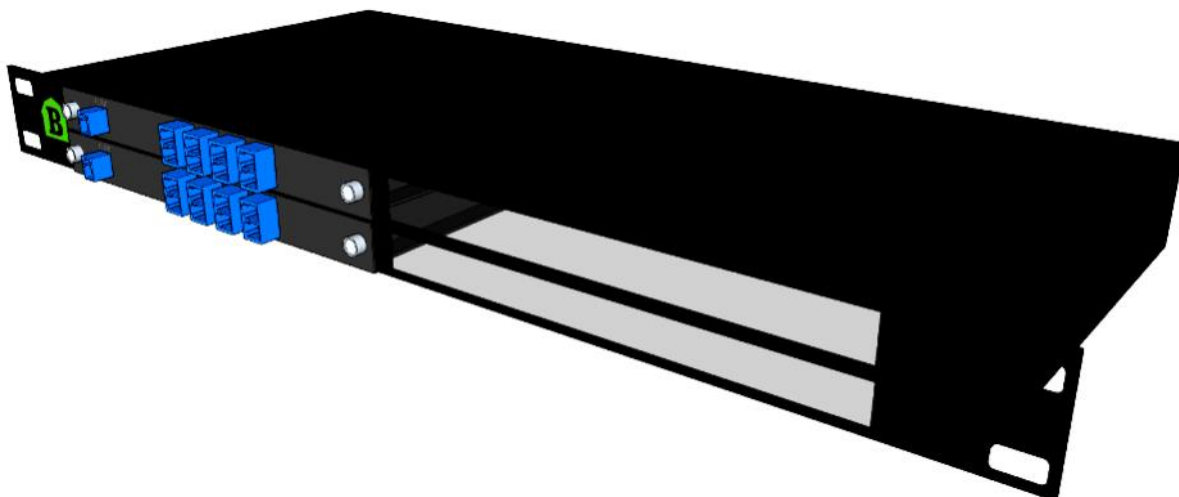

BT-OCS-2-LGX - Optical Change-Over Switch

BT-OCS-2-LGX is a passive change over unit, which is triggered by an externally provided 5V signal. In combination with optical splitters it provides a redundant optical transmission of any optical signal, combined or single wavelengths.



BT-OCS-2-LGX



BT-SPLIT-X:X-LGX - Optical Splitter (Passive Distribution)



BT-SPLIT-1:2-LGX



BT-SPLIT-1:4-LGX

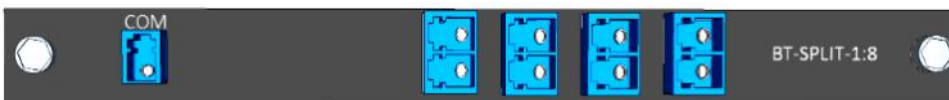

BT-SPLIT-1:8-LGX

Technical Specifications

Optical Ports

- LC/PC connectors
- Insertion Loss <math><1,2\text{dB} + 3, 6 \text{ or } 9\text{ see figures}</math>
- Adjacent Channel Isolation >35dB
- Non-Adjacent Channel Isolation >45dB
- Polarisation dependant loss <math><0.10\text{dB}</math>

Model Name

- BT-SPLIT-1:2-LGX / BT-SPLIT-1:4-LGX / BT-SPLIT-1:8-LGX

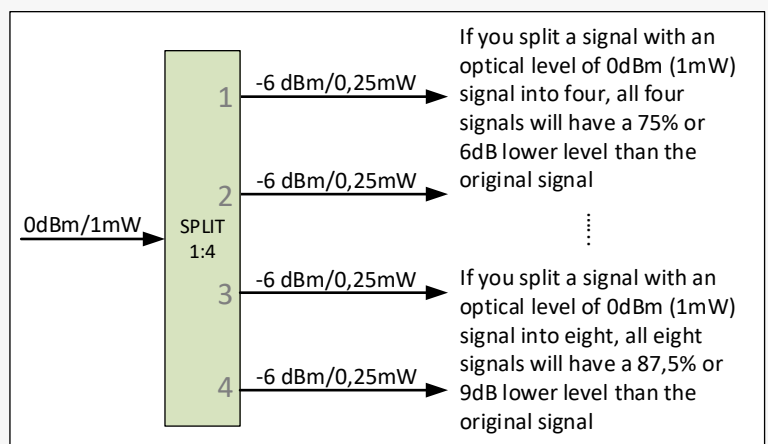
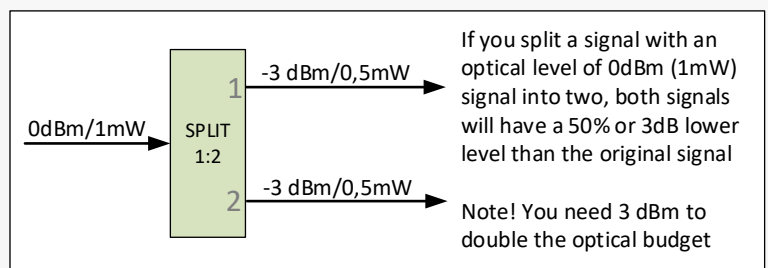

System Example - Optical Split and Change-Over

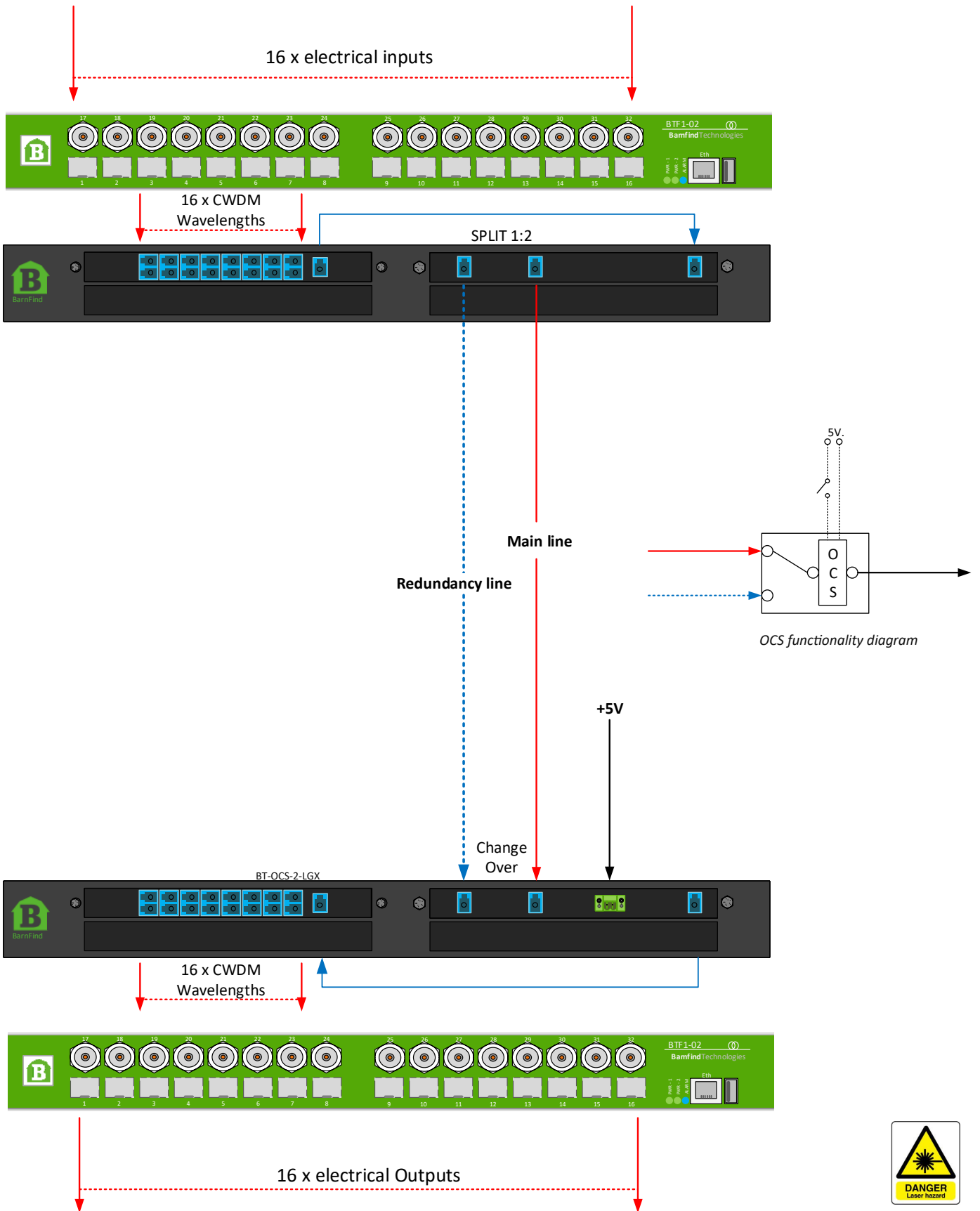

CWDM - (De)Multiplexer

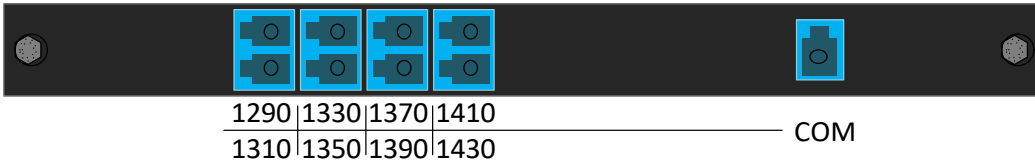

BT-CWDM-MUX-08-LGX

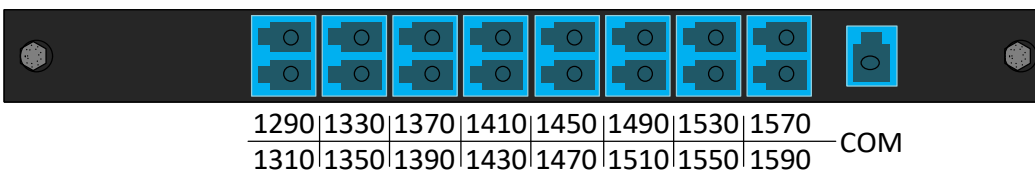

BT-CWDM-MUX-16-LGX

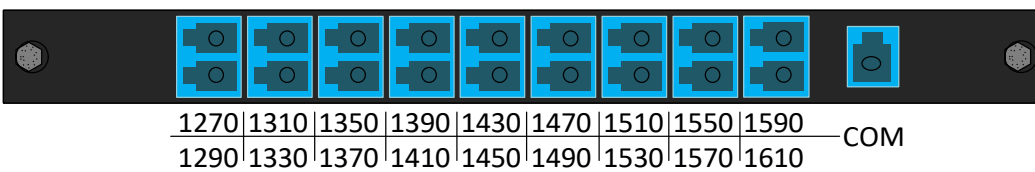

BT-CWDM-MUX-18-LGX

Technical Specifications

Optical Ports

- LC/PC connectors
- Center Wavelengths according to ITU-T G.694.2
- Channel center wavelengths 1270 - 1610nm
- Channel clear passband +/- 7nm
- Insertion Loss 8-ch: -2.0dB; 16-/18-ch: -3.2dB (max.)
- Passband ripple <0,5 dB
- Adjacent Channel Isolation >30dB
- Non-Adjacent Channel Isolation >45dB
- Polarisation dependant loss <0,1dB
- Directivity >45dB
- Return loss >45dB
- Polarisation Mode Dispersion <0,2ps

Model Name

- BT-CWDM-MUX-08-LGX / BT-CWDM-MUX-16-LGX / BT-CWDM-MUX-18-LGX

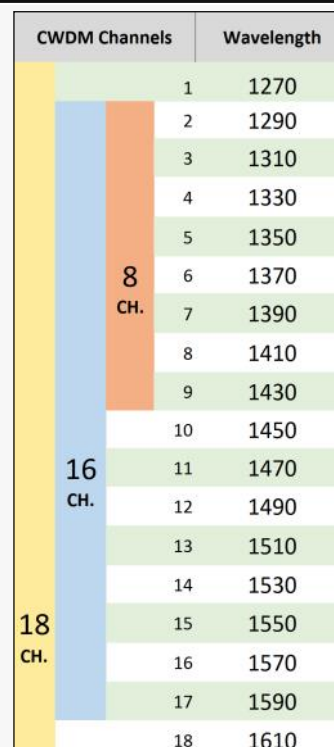

Housing for LGX-Modules

Order Number	Description
BT-HOUS-LGX-1RU	Barnfind standard empty chassis for up to 4 LGX Boxes in 1RU

CWDM (De-)Multiplexer

Fit into BT-HOUS-LGX-1RU

Order Number	Description
BT-WDM-LGX	2 channels (1310/1550nm) in LGX box stand-alone
BT-CWDM-MUX-08-LGX	8 channels (1290-1430nm) in LGX box stand-alone
BT-CWDM-MUX16-LGX	16 channels (1290-1590nm) in LGX box stand-alone
BT-CWDM-MUX-18-LGX	18 channels (1270-1610nm) in LGX box stand-alone

Optical Splitter

Fit into BT-HOUS-LGX-1RU

Order Number	Description
BT-SPLIT-2-LGX	Passive distribution of optical signals 1 In : 2 Out
BT-SPLIT-4-LGX	Passive distribution of optical signals 1 In : 4 Out
BT-SPLIT-8-LGX	Passive distribution of optical signals 1 In : 8 Out

Optical Change-Over Switch

Fit into BT-HOUS-LGX-1RU

Order Number	Description
BT-OCS-2-LGX	Optical Change-Over 2:1; non-latching

Optical Accessories

Order Number	Description
BT-ATT-LC-SM-05	Single-Mode-Attenuator for LC connectors, 5dBm
BT-ATT-LC-MM-05	Multi-Mode-Attenuator for LC connectors, 5dBm
BT-PA-LC/LC-SM-SX-0.5M	Fiber patch cable LC-LC, Single Mode, Simplex
FAULT LOCATOR 8-10km	Visual fault locator optical tester, 10mW
BT-POWER METER	Portable optical power meter
BarnClean	Fiber-Optical Connector-Cleaner
BarnClean Refill	Refill-Cassette for BarnClean



SFPs



SFP [Small Form-factor Pluggable]

is a compact, hot-pluggable transceiver used for both telecommunication and data communications applications. The form factor and electrical interface are specified by a multi-source agreement (MSA). It interfaces a network device motherboard (for a switch, router, media converter or similar device) to a fiber optic or copper networking cable. It is a popular industry format jointly developed and supported by many network component vendors. SFP transceivers are designed to support SONET, Gigabit Ethernet, Fibre Channel, and other communications standards.

Source, Wikipedia

How to read Barnfind's SFPs

Standard SFPs

A transceiver SFP is normally used point to point over short, medium and long distances. The most significant information is; the maximum distance and the maximum data rate.

Note! The RX (receiver) can read all wavelengths, even CWDM wavelengths. See application 'Color converting'

LX = 1310
ZX = 1550

Approx. distance (km)

Barnfind Technologies SM = Singlemode MM = Multimode

BTSFP – LX – SM – 0310

Maximum bitrates:
02 = 1.25Gbps
03 = 2.5Gbps
3G = 3G SDI



BIDI SFPs

BIDI SFPs has a WDM multiplexer integrated to transmit and receive on the same port. Normally used for a point to point transmission with only one (1) single fiber.

Barnfind Technologies

Approx. distance (km)

A: 1310nm
B: 1550nm

BTSFP – WDM – 0220 A/B

Maximum bitrates:
02 = 1.25Gbps
03 = 2.5Gbps
3G = 3G SDI

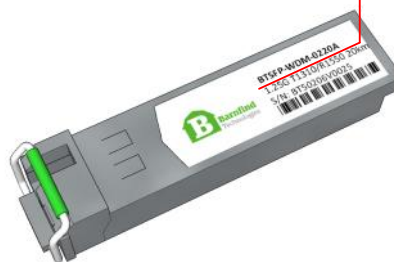



CWDM SFPs

To be able to multiplex a number of signals in one optical fiber, each CWDM channel must have an unique wavelength (frequency). The label of a Barnfind SFP describes the approximate distance, maximum data rate and wavelength. *Due to a limitation of characters, the wavelength is shorten down to the two middle digits.*

Barnfind Technologies	Approx. distance (km)	Max. bitrate	
BT - CWDM - 10 - 3G31	10	3G31	• 1270
			• 1290
			• 1310
			• 1330
			• 1350
			• 1370
			• 1390
			• 1410
			• 1430
			• 1450
			• 1470
			• 1490
			• 1510
			• 1530
			• 1550
			• 1570
			• 1590
			• 1610



HiLo SFPs

The HiLo SFPs are BIDI SFPs with CWDM transmitter. The SFPs are using a narrow channel spacing, and allows you to transmit 2 channels into 1 standard CWDM wavelength. Can be used with a standard CWDM optical multiplexer. They are labeled with **H** (high) or **L** (low) and work as pair in the link.

Barnfind Technologies	Max. bitrate	H: High L: Low	
BT - 3G - 49 - H	3G	49 - H	• 1270
			• 1290
			• 1310
			• 1330
			• 1350
			• 1370
			• 1390
			• 1410
			• 1430
			• 1450
			• 1470
			• 1490
			• 1510
			• 1530
			• 1550
			• 1570
			• 1590
			• 1610



Other SFPs

Any SFP transceiver following the MSA pinout can be used inside Barnfind's BarnOne or BarnMinis. Barnfind does accept SFPs from other manufacturers and welcomes customers to use

SFP - Media Converter

Some SFPs offer integrated media conversion:

- RJ45 connector for Ethernet
- HDMI converting to SDI
- HD-BNC for SDI
- HD-BNC for CVBS converting to SDI



Data Sheet - Example

BTSFP-LX-SM-3G02

3G-SDI Video SFP MSA 1310nm 2km LC Single-Mode Optical Transceiver DDM

The **BTSFP-LX-SM-3G02** is a Single mode transceiver module designed to transmit/receive optical serial digital signals as defined in SMPTE 297-2006. It supports from 50Mbps to 3 Gbps and is specifically designed for transmitted the SMPTE 259M, SMPTE 344M, SMPTE 292M and SMPTE 424M SDI pathological patterns. It is with the SFP 20-pin connector to allow hot plug capability. Digital diagnostic functions are available via an I²C. It is with 1310nm VCSEL transmitters. The transmitter can transmit signal from 50 Mbps to 3 Gbps with up to 2km of Single mode fiber. A maximum distance of 2km is achievable with 3Gbps pathological signals.

Features

- SMPTE 297-2006 Compatible
- Hot-Pluggable SFP Footprint LC Optical Transceiver
- Small Form-Factor Pluggable (SFP) MSA compatible
- Speed from 50Mbps to 3Gbps with up to 2km Single mode Fiber
- Distance up to 2km for 3G-SDI
- Support Video Pathological Patterns for SD-SDI, HD-SDI and 3G-SDI
- SFF-8472 Digital Diagnostic Function
- Single +3.3 V Power Supply
- RoHS-6 Compliant
- 0 to 70oC Operation
- Hot Pluggable
- Class 1 Laser International Safety Standard IEC-60825 Compliant

Application:

- SMPTE 297-2006 Compliant Electrical-to-Optical Interfaces
- High-density Video Routers

Absolute Maximum Ratings

Exposure to absolute maximum rating conditions for extended periods may affect device reliability.

Absolute Maximum Ratings					
Parameter	Symbol	Min	Max	Units	Notes
Storage Temperature	Tstg	-40	85	°C	
Operating Case Temperature	Tc	0	70	°C	
Power Supply Voltage	Vcc	0	4	V	
ESD Tolerance on all pins			1	KV HBM	
Relative Humidity	---	5	95	% RH	non-condensing



Recommended Operating Conditions					
Parameter	Symbol	Min	Typ	Max	Units / Notes
Power Supply Voltage	V _{cc}	3.13	3.3	3.47	V
Operating Case Temperature	T _c	0		70	°C
Baud Rate		50		3000	Mb/s
Power Supply Current	I _{cc}		200	300	mA

Transmitter Specifications (0°C < T _c < 70°C, 3.13V < V _{cc} < 3.47V)						
Parameter	Symbol	Min	Typ	Max	Units	Notes
Optical						
Optical Transmit Power	P _o	-5	-2	0	dBm	1
Output Center Wavelength	λ	1290	1310	1330	nm	At 25°C
Output Spectrum Width	Δλ	---	1.5	3	nm	RMS (σ)
Extinction Ratio	ER	5	7.5		dB	
Relative Intensity Noise	RIN			-120	dB/Hz	
Optical Rise Time / Fall Time	tr / tf			135	ps	2, SMPTE 424M
				270	ps	2, SMPTE 292M
				800	ps	2, SMPTE 344M
				1.5	ns	2, SMPTE 259M
Electrical						
Differential Input Voltage	V _{IH} - V _{IL}	200		1200	mVp-p	AC coupled input
Disable Input Voltage -- Low	V _{TDIS,L}	0		0.8	V	TX Output Enabled
Disable Input Voltage -- High	V _{TDIS,H}	2.0		V _{cc} +0.3	V	TX Output Disabled
SCL, SDA	V _{OH}	2.5		V _{cc} +0.3	V	
	V _{OL}	0		0.5	V	

Receiver Specifications (0°C < T _c < 70°C, 3.13V < V _{cc} < 3.47V)						
Parameter	Symbol	Min	Typ	Max	Units	Notes
Optical						
Wavelength of Operation		1260	---	1620	nm	
Sensitivity for SMPTE 424M 2.97 Gb/s	Sen	0	---	-18	dBm	Pathological
		0	---	-20	dBm	PRBS 2 ²³ -1, BER=1E-12
Sensitivity for SMPTE 292M 1.485 Gb/s	Sen	0	---	-20	dBm	Pathological
		0	---	-21	dBm	PRBS 2 ²³ -1, BER=1E-12
Signal Detect -- Asserted	Pa	---	---	-20	dBm	Transition: low to high
Signal Detect -- Deasserted	Pd	-29	---	---	dBm	Transition: high to low
Signal detect -- Hysteresis		1		6	dB	
Optical Return Loss			-27		dB	
Electrical						
CML Output (Differential)		550	660	850	mVp-p	AC coupled output

Optical Rise Time / Fall Time	tr / tf			135	ps	3, SMPTE 424M
				270	ps	3, SMPTE 292M
				800	ps	3, SMPTE 344M
				1.5	ns	3, SMPTE 259M
Output LOS Voltage -- Low	V _{OL}	0		0.5	V	I _{OL} =-1.6mA, 1 TTL unit load
Output LOS Voltage -- High	V _{OH}	2.5		V _{cc} +0.3	V	I _{OH} =40μA, 1 TTL unit load
SCL, SDA	V _{OH}	2.5		V _{cc} +0.3	V	
	V _{OL}	0		0.5	V	

All statements, technical information, and recommendations related to the products herein are based upon information believed to be reliable or accurate. However, the accuracy or completeness thereof is not guaranteed, and no responsibility is assumed for any inaccuracies. Please contact Barnfind Technologies AS for more information.

BT-CWDM-10-3GXX

3G CWDM Video SFP Single-Mode 1270-1610nm 10KM DDM

The **BT-CWDM-10-3GXX** is a single mode transceiver module designed to transmit/receive optical serial digital signals as defined in SMPTE 297-2006. It supports from 50Mbps to 3 Gbps and is specifically designed for transmitted the SMPTE 259M, SMPTE 344M, SMPTE 292M and SMPTE 424M SDI pathological patterns. It is with the SFP 20-pin connector to allow hot plug capability. Digital diagnostic functions are available via an I2C. This module is designed for single mode fiber and operates at a nominal wavelength of CWDM wavelength. There are eighteen center wavelengths available from 1270 nm to 1610 nm, with each step 20 nm. A guaranteed minimum optical link budget of 20 dB is offered. The transmitter section uses a multiple quantum well CWDM DFB laser and is a class 1 laser compliant according to International Safety Standard IEC-60825. The receiver section uses an integrated InGaAs detector preamplifier (IDP) mounted in an optical header and a limiting post-amplifier IC.

Features

- SMPTE 297-2006 Compatible
- Hot-Pluggable SFP Footprint LC Optical Transceiver
- Small Form-Factor Pluggable (SFP) MSA compatible
- Speed from 50Mbps to 3Gbps with up to 10km Singlemode Fiber
- Support Video Pathological Patterns for SD-SDI, HD-SDI and 3G-SDI
- Power Budget > 20 dB
- 18-CH CWDM: 1270 nm to 1610 nm
- SFF-8472 Digital Diagnostic Function
- Single +3.3 V Power Supply
- RoHS-6 Compliant
- 0 to 70oC Operation
- Hot Pluggable
- Class 1 Laser International Safety Standard IEC-60825 Compliant

Application:

- SMPTE 297-2006 Compliant Electrical-to-Optical Interfaces
- High-density Video Routers

Absolute Maximum Ratings

CWDM* Wavelength (0 to 70°C)

Central Wavelength	Min. (nm)	Typ. (nm)	Max. (nm)	Clasp Color Code	Central Wavelength	Min. (nm)	Typ. (nm)	Max. (nm)	Clasp Color Code
-C270	1264.5	1270	1277.5	Light Purple	-C450	1444.5	1450	1457.5	Yellow Orange
-C290	1284.5	1290	1297.5	Sky Blue	-C470	1464.5	1470	1477.5	Gray
-C310	1304.5	1310	1317.5	Yellow Green	-C490	1484.5	1490	1497.5	Violet
-C330	1324.5	1330	1337.5	Yellow Ocher	-C510	1504.5	1510	1517.5	Blue
-C350	1344.5	1350	1357.5	Pink	-C530	1524.5	1530	1537.5	Green
-C370	1364.5	1370	1377.5	Beige	-C550	1544.5	1550	1557.5	Yellow
-C390	1384.5	1390	1397.5	White	-C570	1564.5	1570	1577.5	Orange
-C410	1404.5	1410	1417.5	Silver	-C590	1584.5	1590	1597.5	Red
-C430	1424.5	1430	1437.5	Black	-C610	1604.5	1610	1617.5	Brown

CWDM*: 18 Wavelengths from 1270 nm to 1610 nm, each step 20 nm.



Absolute Maximum Ratings						
Parameter	Symbol	Min	Max	Units	Notes	
Storage Temperature	Tstg	-40	85	°C		
Operating Case Temperature	Tc	0	70	°C		
Power Supply Voltage	Vcc	0	4	V		
ESD Tolerance on all pins			1	KV HBM		
Relative Humidity	---	5	95	% RH	non-condensing	

Recommended Operating Conditions						
Parameter	Symbol	Min	Typ	Max	Units / Notes	
Power Supply Voltage	Vcc	3.13	3.3	3.47	V	
Operating Case Temperature	Tc	0		70	°C	
Baud Rate		50		3000	Mb/s	
Power Supply Current	Icc		200	300	mA	

Transmitter Specifications (0°C < Tc < 70°C, 3.13V < Vcc < 3.47V)						
Parameter	Symbol	Min	Typ	Max	Units	Notes
Optical						
Optical Transmit Power	Po	-8		-3	dBm	1
Output Center Wavelength	λ	$\lambda_c - 5.5$	λ_c	$\lambda_c + 7.5$	nm	2
Output Spectrum Width	$\Delta\lambda$	---		1	nm	-20 dB width
Side Mode Suppression Ratio	SMSR	30			dB	
Extinction Ratio	ER	5	7.5		dB	
Relative Intensity Noise	RIN			-120	dB/Hz	
Optical Rise Time / Fall Time	tr / tf			135	ps	3, SMPTE 424M
				270	ps	3, SMPTE 292M
				800	ps	3, SMPTE 344M
				1.5	ns	3, SMPTE 259M
Electrical						
Differential Input Voltage	$V_{IH} - V_{IL}$	200		1200	mVp-p	AC coupled input
Disable Input Voltage -- Low	V_{TDSL}	0		0.8	V	TX Output Enabled
Disable Input Voltage -- High	V_{TDSH}	2.0		$V_{cc} + 0.3$	V	TX Output Disabled
SCL, SDA	V_{OH}	2.5		$V_{cc} + 0.3$	V	
	V_{OL}	0		0.5	V	

Receiver Specifications (0°C < Tc < 70°C, 3.13V < Vcc < 3.47V)						
Parameter	Symbol	Min	Typ	Max	Units	Notes
Optical						
Wavelength of Operation		1260	---	1620	nm	
Sensitivity for SMPTE 424M 2.97 Gb/s	Sen	0	---	-18	dBm	Pathological
		0	---	-20	dBm	PRBS 2 ²³ -1, BER=1E-12
Sensitivity for SMPTE 292M 1.485 Gb/s	Sen	0	---	-20	dBm	Pathological
		0	---	-21	dBm	PRBS 2 ²³ -1, BER=1E-12
Signal Detect -- Asserted	Pa	---	---	-20	dBm	Transition: low to high
Signal Detect -- Deasserted	Pd	-29	---	---	dBm	Transition: high to low
Signal detect -- Hysteresis		1		6	dB	
Optical Return Loss			-27		dB	

All statements, technical information, and recommendations related to the products herein are based upon information believed to be reliable or accurate. However, the accuracy or completeness thereof is not guaranteed, and no responsibility is assumed for any inaccuracies. Please contact Barnfind Technologies AS for more information.

SFP Transceiver Modules - Singlemode

Order Number	Max. Data Rate	Distance	nm	Compatibility
BTSFP-LX-SM-0220	1.25Gbps	20km	1310nm	Ethernet, SD-SDI, ASI, AES, MADI
BTSFP-LX-SM-0240	1.25Gbps	40km	1310nm	
BTSFP-ZX-SM-0280	1.25Gbps	80km	1550nm	
BTSFP-LX-SM-0310	2.5Gbps	10km	1310nm	HD-SDI
BTSFP-LX-SM-0340	2.5Gbps	40km	1310nm	Note! Does not support pathological patterns!
BTSFP-ZX-SM-0380	2.5Gbps	80km	1550nm	
BTSFP-LX-SM-3G02	3G	2km	1310nm	SD/HD/3G-SDI
BTSFP-LX-SM-3G20	3G	20km	1310nm	
BTSFP-ZX-SM-3G40	3G	40km	1550nm	

SFP+ Transceiver Modules - Singlemode

Order Number	Max. Data Rate	Distance	nm	Compatibility
BT-LX-SM-10G20	10G	20km	1310nm	Ethernet
BTSFP-LX-SM-6G	6Gbps	20km	1310nm	6G/3G/HD/SD-SDI
BTSFP-LX-SM-12G	12Gbps	10km	1310nm	12G/6G/3G/HD-SDI

SFP Transceiver Modules - Multimode

Order Number	Max. Data Rate	Distance	nm	Compatibility
BTSFP-MM-1G550	1Gbps	550m	850nm	Ethernet
BTSFP-MM-1G	1Gbps	2km	1310nm	Ethernet, MADI
BTSFP-MM-2G550	2Gbps	550m	850nm	SD/HD-SDI
BTSFP-MM-3G02	3Gbps	2km	1310nm	SD/HD/3G-SDI

SFP - BiDi Transceiver Modules - Singlemode

Order Number	Max. Data Rate	Distance	nm	Compatibility
BTSFP-WDM-0220A/B	1.25Gbps	20km	1310/1550nm	Ethernet, SD-SDI, ASI, AES, MADI
BTSFP-WDM-0240A/B	1.25Gbps		1310/1550nm	
BTSFP-WDM-0280A/B	1.25Gbps	80km	1490/1550nm	
BTSFP-WDM-0310A/B	2.5Gbps	10km	1310/1550nm	HD-SDI
BTSFP-WDM-0340A/B	2.5Gbps	40km	1310/1550nm	Note! Does not support pathological patterns!
BTSFP-WDM-0380A/B	2.5Gbps	80km	1490/1550nm	
BTSFP-WDM-3G20A/B	3Gbps	20km	T1310/R1550nm	SD/HD/3G-SDI



SFP CWDM Transceiver Modules - Singlemode

Order Number	Max. Data Rate	Distance	nm	Compatibility
BT-CWDM-40-02XX	1.25Gbps	40km	1270-1610nm	Ethernet, SD-SDI, ASI, AES, MADI
BT-CWDM-80-02XX	1.25Gbps	80km	1270-1610nm	
BT-CWDM-40-03XX	2.5Gbps	40km	1270-1610nm	HD-SDI
BT-CWDM-80-03XX	2.5Gbps	80km	1270-1610nm	No pathological patterns
BT-CWDM-10-3GXX	3Gbps	10km	1270-1610nm	SD/HD/3G-SDI
BT-CWDM-40-3GXX	3Gbps	40km	1270-1610nm	
BT-CWDM-80-3GXX	3Gbps	80km	1270-1610nm	No pathological patterns

SFP+ CWDM Transceiver Modules - Singlemode

Order Number	Max. Data Rate	Distance	nm	Compatibility
BT-CWDM-10-10GXX	10Gbps	10km	1270-1610nm	Ethernet
BT-CWDM-40-10GXX	10Gbps	40km	1270-1450nm	Ethernet
BT-CWDM-10-12GXX	12Gbps	40km	1270-1330nm	up to 12G-SDI

SFP HiLo CWDM Transceiver Modules - Singlemode

Order Number	Max. Data Rate	Distance	nm	Compatibility
BT-3G-XX-H/L	3Gbps	20km	1270-1610nm	SD/HD/3G-SDI

Other SFPs

Order Number	Description
EB30HDRT-MM	SDI SFP (emSFP) Coaxial Transceiver, medium reach, MSA, HD-BNC
EB30CSRT-MM	SDI SFP (emSFP) Coaxial Transceiver, medium reach, MSA, DIN 1.0/2.3
EB34TD1R-SM	HDMI to 3Gbps SDI Converter, SFP Receiver (emSFP), MSA, Type D with retention clip
EB34TD1T-SM	SDI to HDMI/DVI Converter, SFP Transmitter (emSFP), MSA, Type D with retention clip
EB30CSRT-AM	CVBS to SDI Converter, SFP (emSFP) Coaxial Transceiver, MSA, DIN1.0/2.3
EB30HDRT-AM	CVBS to SDI Converter, SFP (emSFP) Coaxial transceiver, MSA, HD-BNC
BTSFP-Gbase-CU	10/100/1000 Mbit/s Ethernet



BarnAcademy

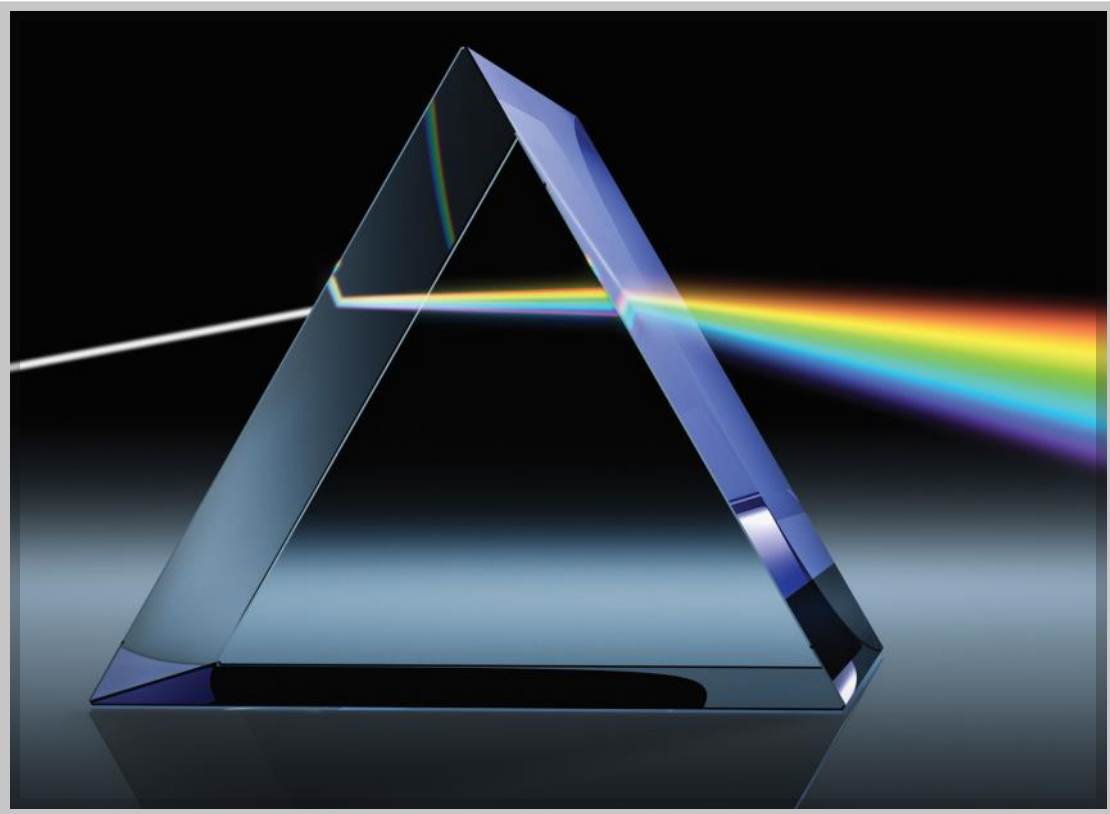

WDM - Wavelength Division Multiplexing

Wavelength Division
Multiplexing is a way to transmit two (2) individual signals in one fiber. The BIDI SFP modules are specially made for this purpose. Those SFPs are always working as a pair (A/B) using two different transmitting wavelengths (A:1310nm and B:1550nm). The multiplexer is integrated in the SFP. With a stand alone WDM mux at either end of the fiber, it is possible to have 2 signals traveling the same direction on the fiber.

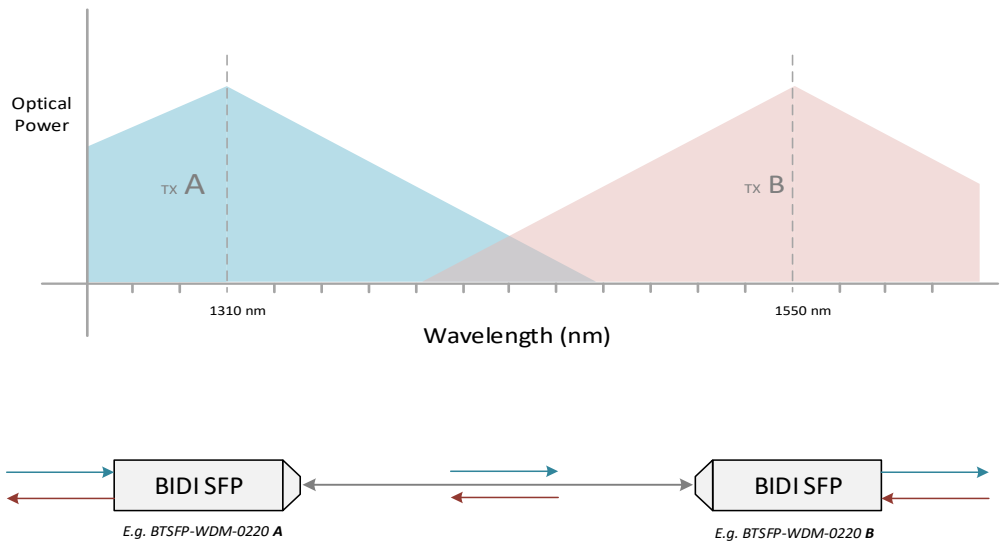

CWDM - Coarse Wavelength Division Multiplexing

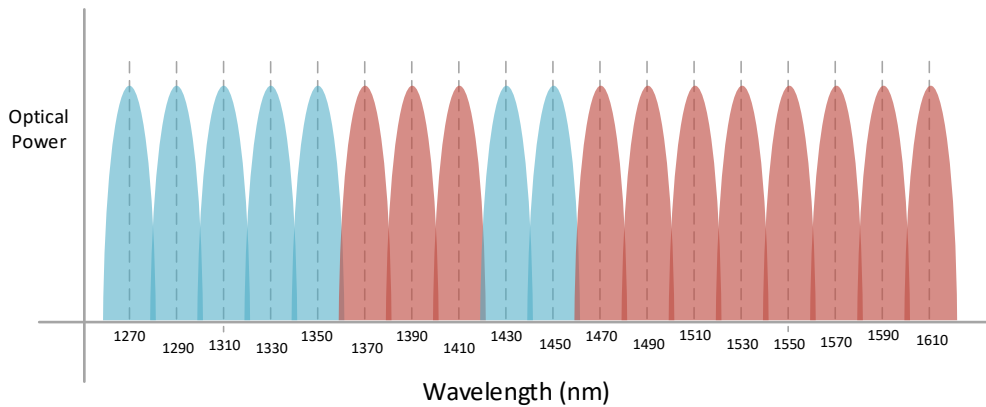

Coarse Wavelength Division Multiplexing (ITU-T G694.2) allows up to 18 signals to travel on one fiber strand. Any protocol can travel beside another over the same link, as long as it is a specific wavelength. (e.g. HD-SDI @1570nm can be transported alongside 3G-SDI @1590nm and MADI @1510nm). This allows for longterm proofing of the infrastructure, because the multiplexers simply refract light at any speed/bitrate, regardless of the protocol being deployed. Channel spacing is 20nm.

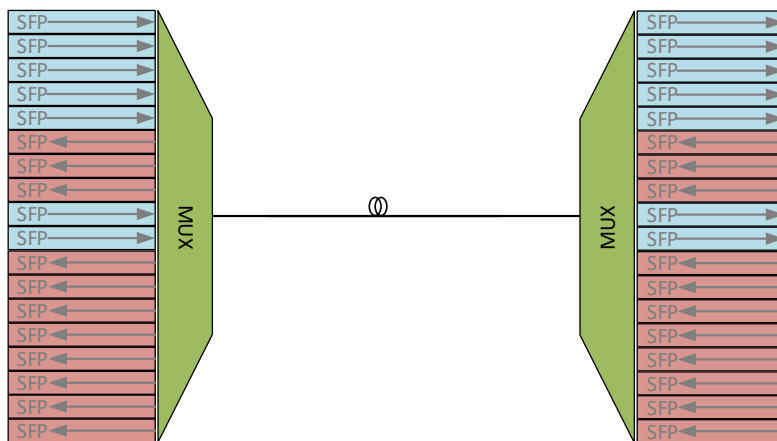

HiLo-Technology

offers the possibility to double the signal count traveling on one fiber using standard CWDM multiplexers in combination with bi-directional HiLo-SFPs

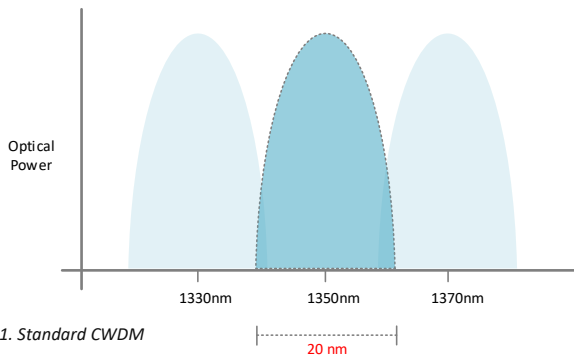

Fig 1. Standard CWDM

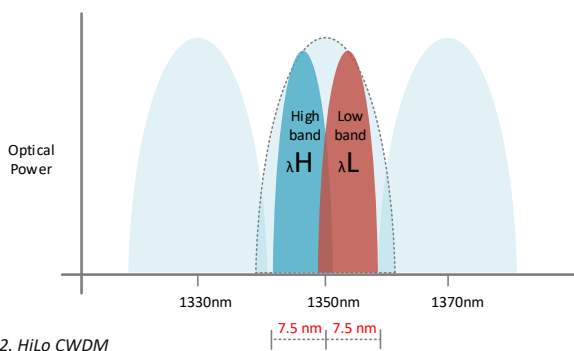

Fig 2. HiLo CWDM

Figure 1. shows the standardized channel spacing for use with CWDM (ITU-T G.694.2). It allows totally 18 channels between 1270nm and 1610nm with 20 nm spacing. Due to this limitation of channels deployed in one (1) fiber, system integrators must always prioritize the signals in order to fit a single fiber transmission architecture. *Keep in mind that some signals are bi-directional (e.g. ethernet), and will occupy 2 channels in your CWDM multiplexer*

Figure 2. Barnfind HiLo SFPs are designed to meet a need for higher density of signals in one single fiber. By using half of the spacing in each wavelength, *HiLo SFPs can double the capacity of the traditional CWDM bi-directional transmission.*

This enables totally 18 bi-directional links (totally 36 channels).

Note!, the HiLo SFPs are designed to be used with a standard optical multiplexer.

Benefits of using HiLo SFP:

- Up to 18 bi-directional channels in one (1) fiber.
- Can be used with standard optical multiplexer
- Can work along with standard CWDM SFPs to increase the number of channels
- Handles bitrates up to 3Gbps.

Typical applications:

- Ethernet transmissions
- Camera to CCU
- Video workflow with return
- Add Drop

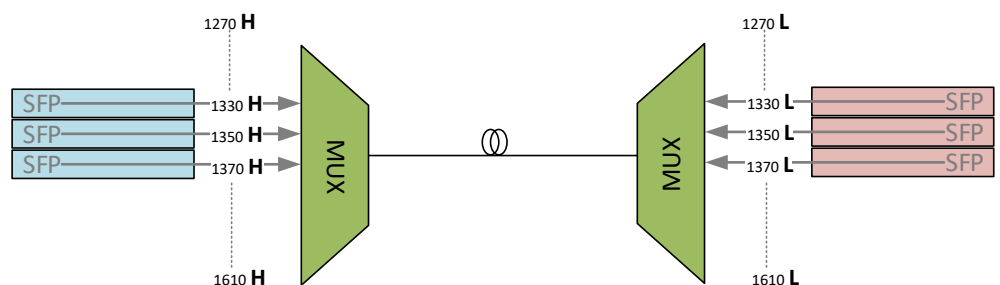
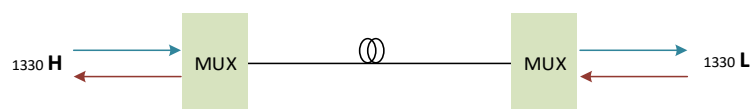

Optical budget calculation

Prior to designing or installing a fiber optic cabling system, a loss budget analysis is recommended to make certain the system will work over the proposed link. That same loss budget will be used as to compare test results after installation of the cabling to ensure that the components were installed correctly. Both the passive and active components of the circuit have to be included in the loss budget calculation. Passive loss is made up of fiber loss, connector loss, and splice loss. Don't forget any couplers or splitters in the link. Active components are system gain, wavelength, transmitter power, receiver sensitivity, and dynamic range. Prior to system turn up, test the circuit with a source and optical power meter to ensure that it is within the loss budget.

Example:

- BTSFP-CWDM-10-3Gxx
- 10 km

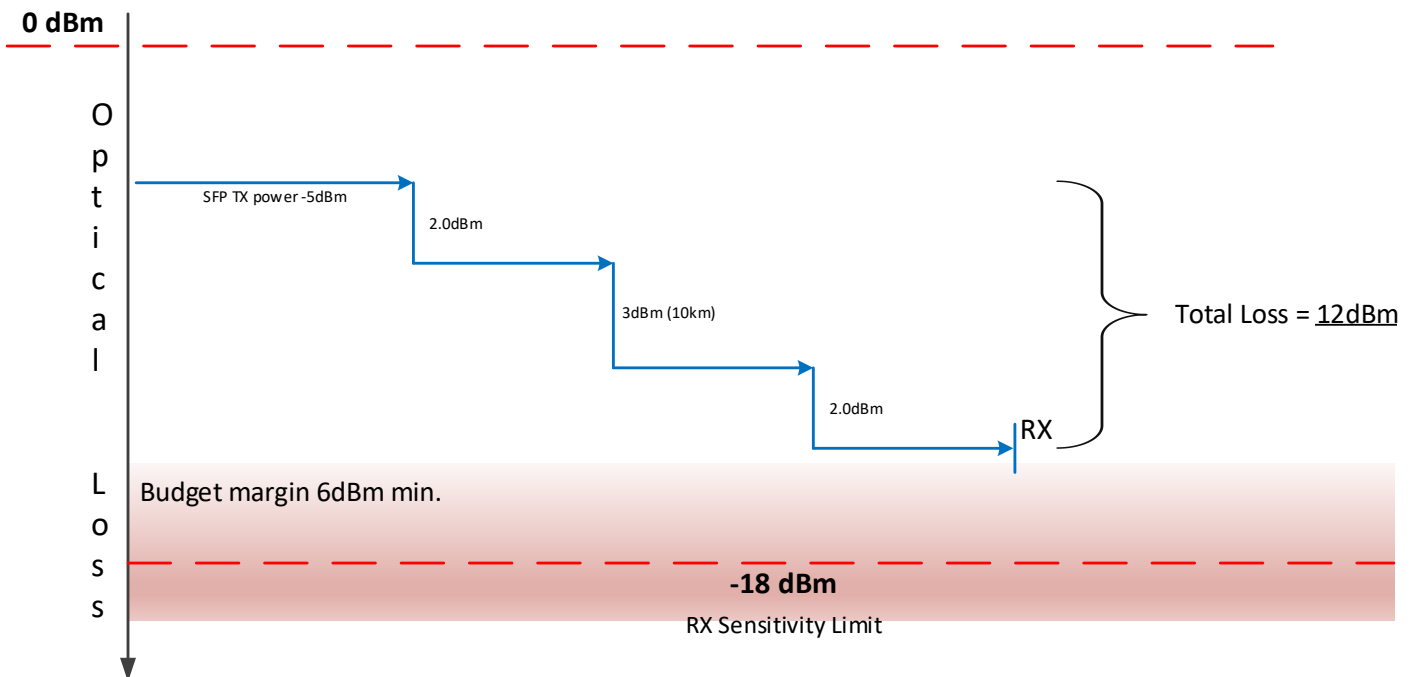
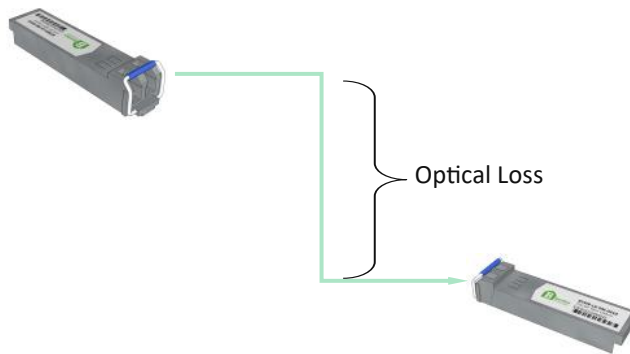

Example shows a simple and very common transmission of a signal from A to B. The numbers refer to maximum values.

Figure on next page shows the same scenario with Barnfind products

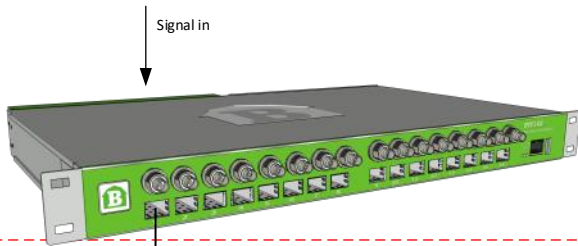

SFP:

BTSFP-CWDM-10-3Gxx

Optical Transmit Power (typ) **-5dBm**



CWDM Multiplexer:

Insertion loss:

- **8ch: 2.0dBm (max)**

- **16ch: 3.2dBm (max)**



Single Mode fiber:

Attenuation:

Typically **0.3dBm** per km

CWDM Multiplexer:

Insertion loss:

- **8ch: 2.0dBm (max)**

- **16ch: 3.2dBm (max)**



SFP:

BTSFP-CWDM-10-3Gxx

RX Sensitivity (3G-SDI) **-18dBm**

Light travelling through fiber

There is normally not a requirement for a system designer, installer or an operator to know the fundamental physics in how the light can travel such long distances in a tiny fiber, but it is definitely a fascinating and interesting phenomena.

Light travels through a fiber-optic cable by bouncing repeatedly off the walls. You might expect a beam of light, traveling in a clear glass pipe, simply to leak out of the edges. But if light hits glass at a really shallow angle (less than 42 degrees), it reflects back in again—as though the glass were really a mirror. This phenomenon is called total internal reflection. It's one of the things that keeps light inside the pipe.

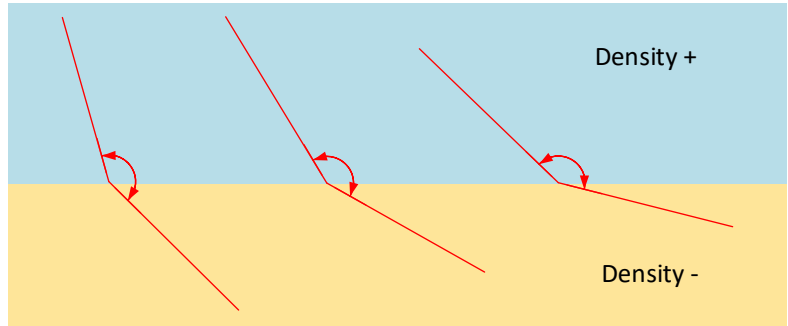

The light is «bending» when it hits a material with lower density. The incoming angle is too sharp, and light will leak.

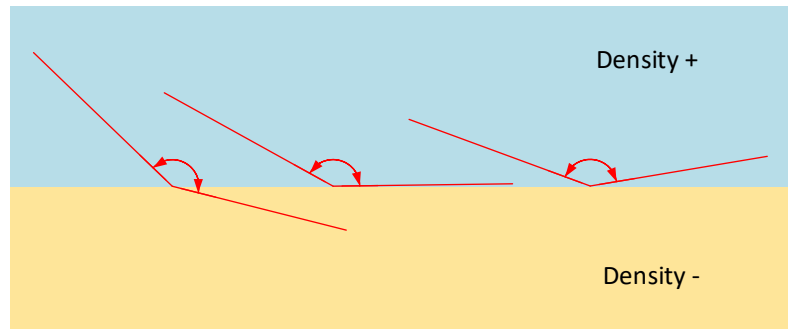

Light always reflects with the same angle as it enters a surface, but when the angle is shallow enough, it will bounce back into the material with higher density again. This sequence repeats when hitting the «roof». See illustration below.

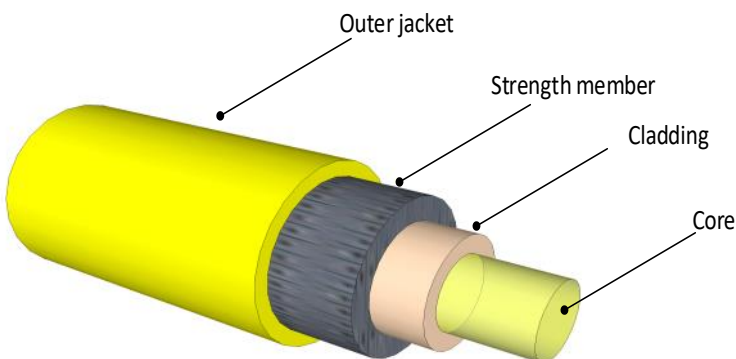
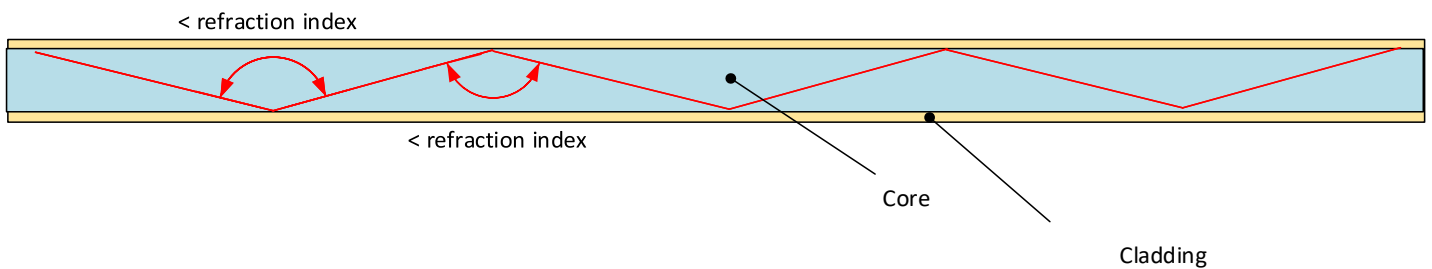

The second factor keeping light in the pipe is the structure of the cable, which is made up of two separate parts. The main part of the cable - in the middle - is called the **core** and that is the part the light travels through. Wrapped around the outside of the core is another layer of glass called **cladding**. The cladding keeps the light signals inside the core, because it is made of a different type of glass than the core itself. More technically, the cladding has a lower refractive index.

The electromagnetic spectrum

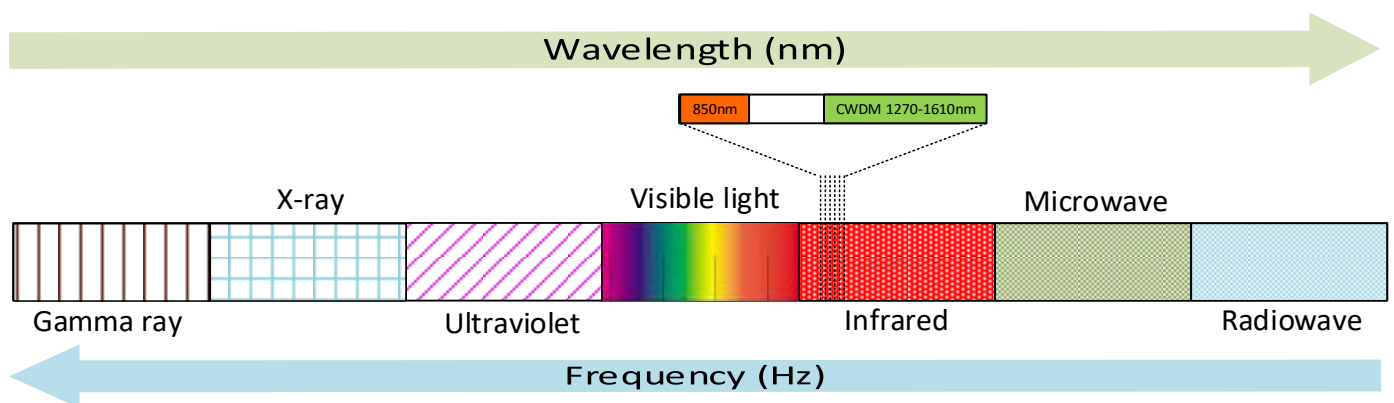

The attenuation/wavelength graph, would suggest that all transmission is best done in the 1550nm window, where the Rayleigh scattering losses are lowest. However, LED and VCSEL (vertical cavity surface emitting laser) sources can currently be manufactured in high volume at very low cost in the 850nm window (multi mode). The higher attenuation due to scattering limits will reduce the transmission distance. Long distance applications (50km+) are owned by transceivers utilizing the 1550nm window. Achieving these distances comes at a price. Sources such as Distributed FeedBack (DFB) and Externally Modulated Lasers (EML) are not easily fabricated in anything but an edge-emitting semiconductor structure, greatly increasing the manufactured cost of these devices. On the receiving side, sophisticated receivers such as Avalanche Photo-Diodes (APDs) also drive up cost. There is a middle ground...the 1310nm window. The availability of inexpensive Fabry-Perot laser sources and simple Positive Intrinsic Negative (PIN) receivers to provide reliable transmission covering a range of 1km to about 50km has made the 1310nm window the third alternative.

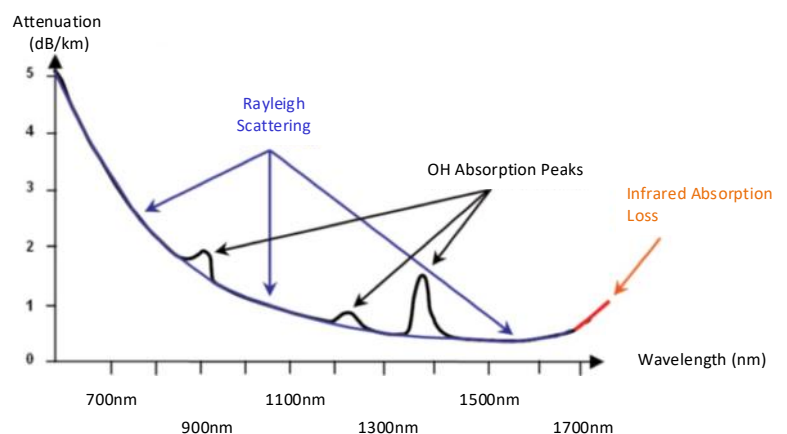

Laser precautions:

One should exercise the same kinds of safety precautions around lasers as with any other power tool or electrical device paying special attention to eye safety.

Do never look directly into a SFP, multiplexer or fiber-end! It may cause severe damage to your eye!





Software & Control



BarnStudio



BarnStudio is first of all a management and configuration tool to be used for BarnOne frames. Further it is a great tool for general monitoring of signal flow and diagnostic of SFPs, BNCs, many different optical parameters, fans, reclockers, equalizers etc.

You can run BarnStudio on any Windows based computer (Windows XP SP2 and higher). For users with other operating systems all BarnOne frames run a web server with the same functionality as BarnStudio.

The next chapter of BarnGuide will explain the functionalities and possibilities in BarnStudio.

Installation

Download latest version of BarnStudio for free, directly from our website. and run «BarnStudio...setup.exe»

<https://www.barnfind.no/downloads/>

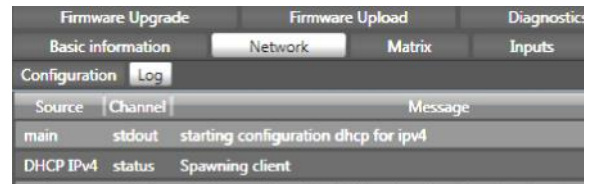

The screenshot displays the BarnStudio interface. On the left, a 'MON' tab is active, showing a 'No group' configuration. A central grid lists 32 input ports (SFP #1-#16 and BNC #17-#32) and 4 output ports (SFP #1-#4). On the right, a detailed configuration panel for SFP #15 and BNC #17-#19 is visible, showing parameters like 'Direction', '3G ext. reach', and 'Coarse amplitude'. The bottom right shows a status bar with 'Enabled' and 'Prescan' indicators.

Overview

The main (and only) window is divided into three columns:

The screenshot shows the main interface of the BarnOne management tool. It is divided into three vertical sections:

- Left Column (Connections):** Contains a 'SNMP trap receiver' status, a 'Multicast search scope' section with checkboxes for IPv4 and IPv6 local/site/org, and a table of devices with columns for 'Device', 'NetConf', and 'Protocol'. The 'Test1' device is highlighted.
- Middle Column (Frame Operations):** Contains 'Basic information' for the selected device (Test1), including model, serial number, network ID, and firmware version. Below this are fields for 'sysName', 'sysLocation', and 'sysContact'. A 'Telnet connection properties' section includes fields for 'Username' (admin), 'Password', 'Host', and 'Port'. A 'Factory Reset' button is also present.
- Right Column (Take List):** Features a large blue house icon with a white letter 'B' inside, and a 'Queue waiting for confirmation' status at the top. At the bottom, there are 'Take' and 'Automatic take' buttons.

Connections

connection properties and device list

Frame Operations

detailed information about the frame which was selected in the connections column

Take List

Every change performed in the Frame Operations section has to be acknowledged in the take list

Factory Reset:

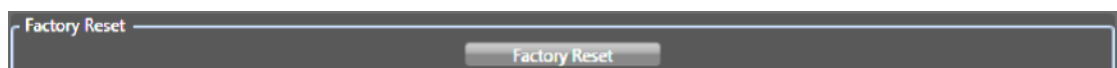

Each BarnOne frame or BarnMini-05 can be reset to it's original factory settings:

- DHCP activated (no IP address)
- Password for Administrator is reset to *no password*

Discover the frames

Note: BTF1-XX is shipped with no IP address set by default, but with DHCP enabled.

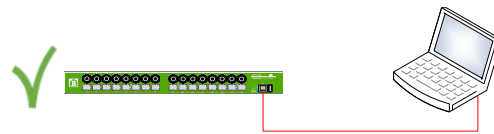

BarnStudio uses multicast for discovering and configuring network parameters for any BTF1-XX frames. The reason for this is that multicast always works regardless of the current IP address/status.

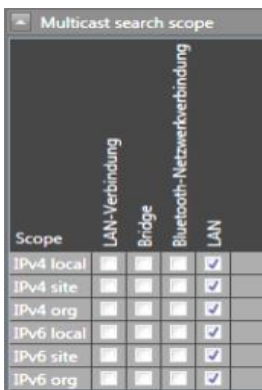

Multicast search scope:

You can select of which network interfaces you want to search for frames on. Each network interface represents one column. *Note! text appears in your local language.* The Multicast search scope offers you multiple different search addresses: local, site and organization search scope, at both IP version 4 and 6. But only one is needed to be selected at any given time for auto discovery of frames to function. Once all frames are detected, the multicast can be turned off, to reduce traffic.

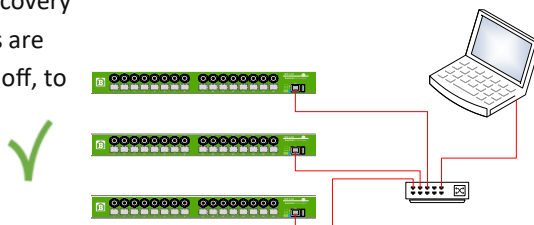

Device List:

All BTF1-XX frames that are discovered will appear in alphabetic order in the Device List. The devices can be renamed under the Basic Information Tab.

NetConf status:

- If you add a new frame and it is not connected, it shows grey color.
- Frame is no longer visible by Multicast autodetection.
- Valid, in operation

Note! If you connect remotly, it might appear as red or grey even if you have a valid connection.

Add:

Push the Add button to manually add more devices.

Remove:

If you right click on a given device you can you will get a Pop up menu where you can select to remove that device.

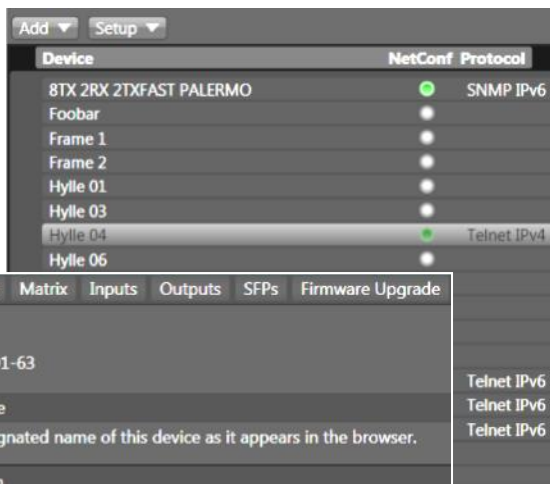

Acknowledgement (*Take*) of configuration changes

You can protect the setup/configuration against unwanted accidental configuration changes. This means that you need to acknowledge the configuration changes that you want to perform/execute before you actually make them hot. You can activate the changes on this right side of the screen one by one or do them all in one operation. If you wish to undo them, you click the "X" button.

Automatic Take:

The acknowledge feature can be temporary disabled for given time periods and can also be canceled at any time. This is typically a function used when you preconfigure the device, or other circumstances were multiple settings needs to be performed.

- Disable
- 5 minutes
- 15 minutes
- 30 minutes
- 1 hour

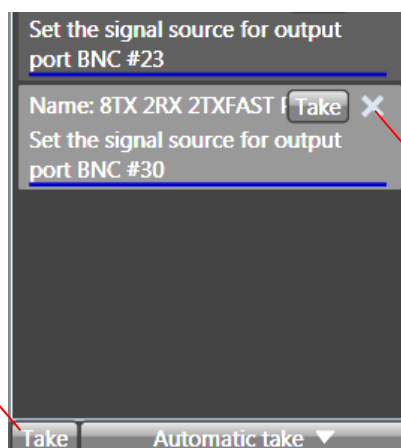

Take all

Undo / do not Take

Basic Information

- **sysName:** Set the name of each BTF1-XX frame (this name will appear in the Device List). Note! Only Latin characters and numbers allowed (ASCII).
- **sysLocation:** Where the device is located
- **sysContact:** Who is responsible for the operation or service of the frame

Basic information	Network	Matrix	Inputs	Outputs	SFPs	Firmware Upgrade	Firmware Upload	Diagnostics	Auth database
Model:	BTF1-02								
SerialNumber:	12435								
NetworkID:	B8-27-EB-EA-D1-63								
sysName:	<input type="text" value="Training frame"/> This is the designated name of this device as it appears in the browser.								
sysLocation:	<input type="text" value="Meeting room"/> This is the location of the device. Here you can type in the site where the device is located, or you can even include more information like rack-address.								
sysContact:	<input type="text"/> Who is the contact person responsible for this device?								

SNMP connection properties:

This section can be used if you want to connect by SNMP to a remote device that can not be auto discovered.

- **Connection status:** If the device is connected, you can read out IP and port information.
- **Force Host/Port:** This enables the possibilities to write in Ip and port number to connect.
- **Host:** The remote IP address you want to connect e.g. 192.168.0.2
- **Port:** Normally this should be 161
- **SNMP Write Community:** This is normally set to private.
- **Detection Status:** This shows the last log lines of connecting status.
- **Download BarnOne MIB :** <https://media.barnfind.no/20171201%20Barnfind%20MIB.zip>

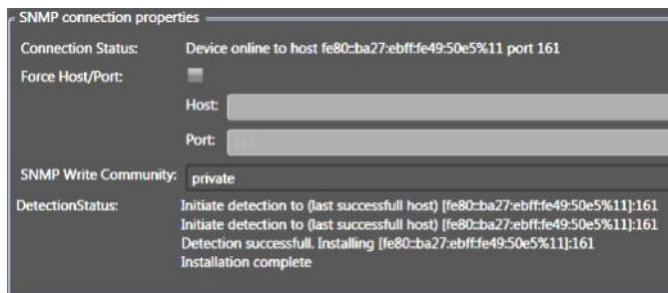

Telnet connection properties:

This section can be used if you want to connect via Telnet to a remote device that can not be auto discovered.

- **Connection status:** If the device is connected, you can read out IP and port information.
- **Force Host/Port:** This enables the possibilities to write in Ip and port number to connect.
- **Host:** The remote IP address you want to connect e.g. 192.168.0.2
- **Port:** Normally this should be 23
- **Detection Status:** This shows the last log lines of connecting status.
- **Download BarOne Telnet documentaion:** <https://media.barnfind.no/BTF1%20Telnet%20Documentation%20revision%201.0.pdf>

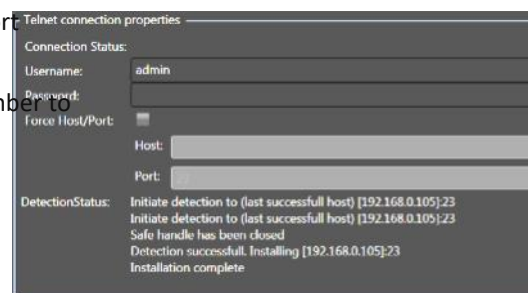

Network

The purpose of this section is to see the current network status. Here you can also download, change and upload the network configuration file.

Note! BarnStudio use prefix length for both IPv4 and IPv6 instead of the traditional netmask. This is due to netmask can only be used for IPv4.

Examples:

Netmask 255.255.255.0 is equal to prefix length 24.

Netmask 255.255.0.0 is equal to prefix length 16.

Netmask 255.0.0.0 is equal to prefix length 8.

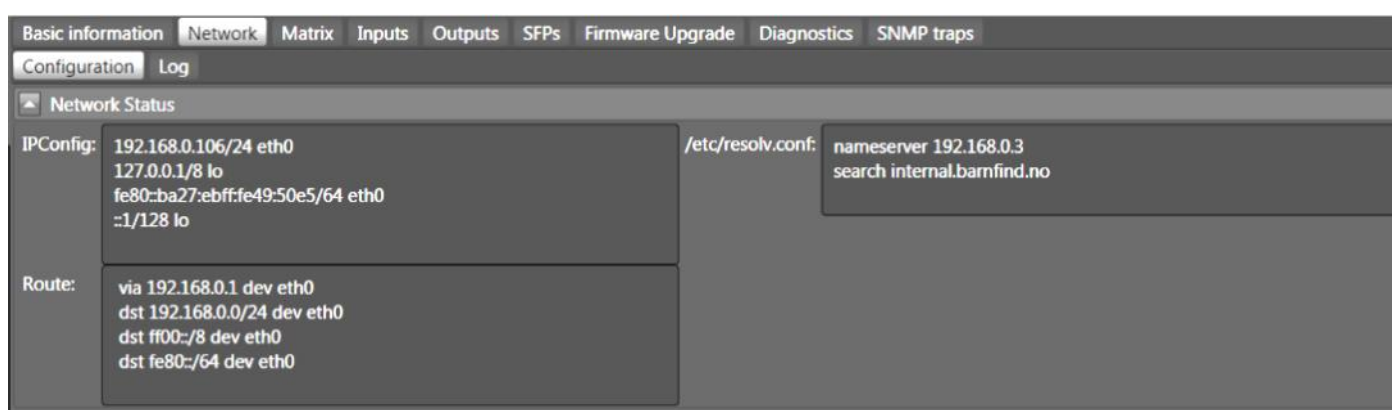

The screenshot shows the 'Network Status' section of the BarnStudio interface. It contains three main areas:

- IPConfig:** Lists IP addresses for interfaces: 192.168.0.106/24 eth0, 127.0.0.1/8 lo, fe80::ba27:ebff:fe49:50e5/64 eth0, and ::1/128 lo.
- Route:** Shows routing entries: via 192.168.0.1 dev eth0, dst 192.168.0.0/24 dev eth0, dst ff00::/8 dev eth0, and dst fe80::/64 dev eth0.
- /etc/resolv.conf:** Shows DNS settings: nameserver 192.168.0.3 and search internal.barnfind.no.

Network Status:

- **IPConfig:** The currently assigned IP addresses.
- **Route:** The currently active routing table.
- **/etc/resolv.conf:** The current DNS resolving configuration file. *This is only used for software upgrades.*

Network Configuration:

This section is for download, change and upload the current configuration file. This section will not be populated until you click "download configuration from device".

IP v.4 configuration mode: Here you can select which configuration mode that should be used. The options are;

- **DHCP/BootP:** This is what the frames are configured with from factory. This is to automatically configure the IP address using a DHCP server.
- **Disable:** Do not configure an IPv4 address.
- **Linklocal (169.254.0.0/16):** To automatically configure the IP address using a Link Local Address.
- **Static:** Use this to manually configure an IP address. This is the recommended setting for the deployment. Get your IP address from your local network administrator.
 - **IP addresses:** Up to 4 different IP addresses. Each address is written with a prefix length (netmask). Each address is separated with a space. Example: 192.168.0.2/24 10.100.10.2/8
 - **Default Gateway:** Default Gateway if any.
 - **DNS Servers:** IP addresses for resolving DNS. This is only used for software upgrades.
 - **DNS Searches:** This feature is for setting the DNS search, normally left blank.

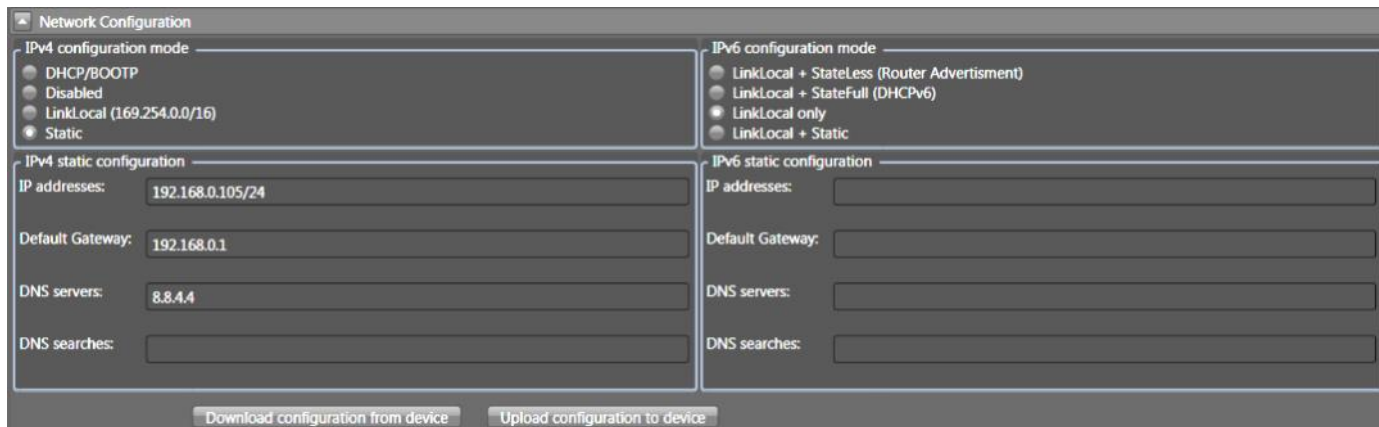

IP v.6 configuration mode: Here you can select which configuration mode that should be used. The options are;

- **LinkLocal + StateFull (DHCPv6):** This is to automatically configure the IP address using a DHCPv6 server.
- **LinkLocal + StateLess (Router advertisement):** This is the factory default. This is to automatically configure the IP address using the new Router advertisement Protocol. This is normally the replacement for DHCP in IPv6.
- **Linklocal only:** To automatically configure the IP address using a Link Local Address only.
- **Linklocal + Static:** Use this to manually configure an IP address. This is the recommended setting for the deployment. Get your IP address from your local network administrator.
 - **IP addresses:** Up to 4 different IP addresses. Each address is written with a prefix length (netmask). Each address is separated with a space. Example: 2001::2/64 2002:1234::4321/64
 - **Default Gateway:** Default Gateway if any.
 - **DNS Servers:** IP addresses for resolving DNS. This is only used for software upgrades.
 - **DNS Searches:** This feature is for setting the DNS search, normally left blank.

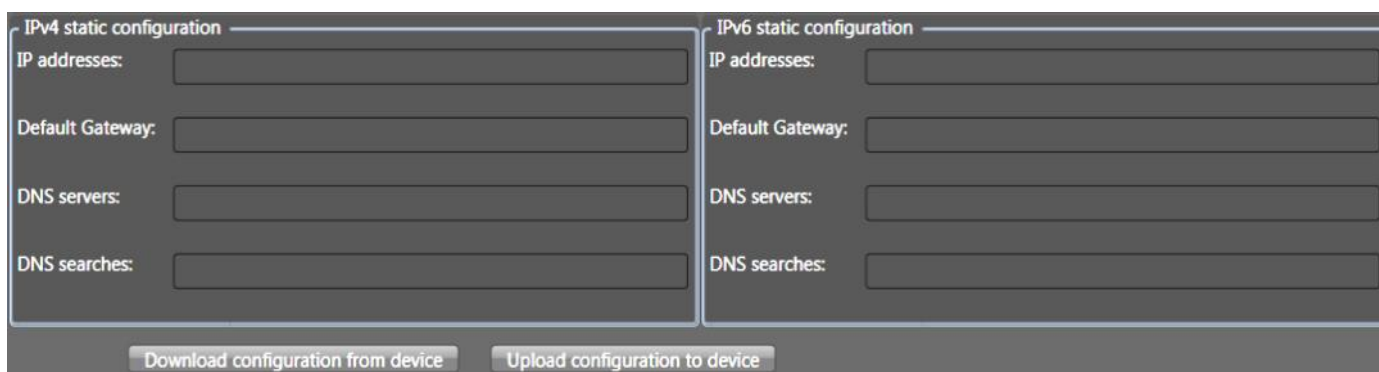

Download Configuration from Device – button

Click this button to download the current configuration file from the device into BarnStudio.

Upload Configuration to Device – button

Click this button to upload the configuration from BarnStudio into the device.

Beneath the Download and Upload buttons, you can see a log of the current transfer (upload/download status).

Log:

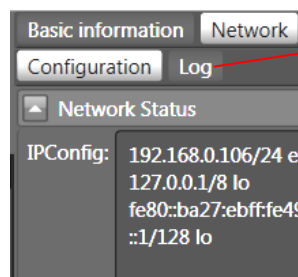

Log: This is a live log from the network configuration software running on the device. Currently it shows information from the DHCP clients.

Note! Download/Upload will first attempt to use Telnet for the transfer. If this fails; the multicast search protocol will be used. It uses the settings from the “multicast search scope” dialog for this.

Matrix

The purpose of this section is to configure the BTF1-XX frames routing of signals. The rows going from top to bottom(Y) are the signal sources. The columns going from left to right (X) are the possible signal destinations. A signal can be routed to as many destinations as you may want, but a destination can only be subscribed to one source at any given time.

Outputs

The color indication are as following:

- **Black:** Not able to detect a signal presence.
- **Red:** No signal detected/loss of signal.
- **Green:** Signal is detected (reclocker is locked).

Inputs

The color indication are as following:

- **Black:** Not able to detect a signal presence.
- **Red:** No signal detected/loss of signal.
- **Green:** Signal is detected.

By default the ports are sorted by channel number. This can be changed to alphabetically order using the **setup** button.

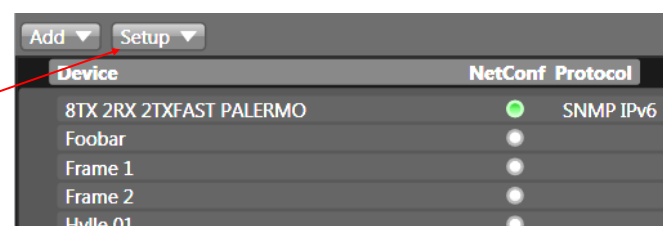

Groups can be defined using the input and output tabs.

Inputs

Configure the signal input ports.

Each input port is represented by one row in the table.

Name	Label	Port Equalizer	Enabled	Prescan	Unknown	Result	Unknown HD	Errors
SFP #1	R1DVD player		Enabled	Prescan	Unknown		Unknown	NOSIGNAL
SFP #2	R1PC		Enabled	Prescan	3G-SDI 1920x1080p	Result	1920x1080/59.94 (1:1), 425M (3G Level A) 4:2:2	Errors none
SFP #3	R1Ani player		Enabled	Prescan	3G-SDI 1920x1080p	Result	1920x1080/59.94 (1:1), 425M (3G Level A) 4:2:2	Errors none
SFP #4	R1Input port 4		Enabled	Prescan	Result			Errors
SFP #5	Input port 5		Enabled	Prescan	Result			Errors

- **Name:** This name of the port is matching the silk print on the front of the BTF1-XX.
- **Label:** This name you may change as you may wish.
- **Groups:** If you want to have grouping of ports in the Matrix tab, you can prefix each label with the name of the group and add a \.

Source \DVD player
Source \PC
Source \Ani player

Name	Label
SFP #1	Source\DVD player
SFP #2	Source\PC
SFP #3	Source\Ani player

Source

SFP #1:	DVD player	<input type="checkbox"/>	<input type="checkbox"/>	<input type="checkbox"/>	<input type="checkbox"/>	<input type="checkbox"/>	<input type="checkbox"/>
SFP #2:	PC	<input type="checkbox"/>	<input type="checkbox"/>	<input type="checkbox"/>	<input type="checkbox"/>	<input type="checkbox"/>	<input type="checkbox"/>
SFP #3:	Ani player	<input type="checkbox"/>	<input type="checkbox"/>	<input type="checkbox"/>	<input type="checkbox"/>	<input type="checkbox"/>	<input type="checkbox"/>
SFP #4:	Input port 4	<input type="checkbox"/>	<input type="checkbox"/>	<input type="checkbox"/>	<input type="checkbox"/>	<input type="checkbox"/>	<input type="checkbox"/>

BNC #17	Input port 17	Direction	Input	3G ext. reach	Coarse amplitude	800mV p-p
BNC #18	Input port 18	Direction	Output	3G ext. reach	Coarse amplitude	800mV p-p
BNC #19	Input port 19	Direction	Output	3G ext. reach	Coarse amplitude	800mV p-p

- **Equalizers:** The BNC ports features a cable equalizer that can be fine-tuned here.
 - * **3G ext reach:** Extends the cable length that the Belden standard allows for a 3G signal.
 - * **Coarse amplitude:** The expected input voltage of the signal. Normally it should be 800mV.
- **Direction:** Changes the signal direction for this BNC port. Each port can individually be defined to be either an input or an output.

SFP #2	R1PC	Enabled	Prescan	3G-SDI 1920x1080p	Result	1920x1080/59.94 (1:1), 425M (3G Level A) 4:2:2	Errors none
SFP #3	R1Ani player	Enabled	Prescan	3G-SDI 1920x1080p	Result	1920x1080/59.94 (1:1), 425M (3G Level A) 4:2:2	Errors none
SFP #4	R1Input port 4	Enabled	Prescan	Result	Errors		

- **Signal analyzer:** Internally in theBTF1-XX frames, there is a SDI deserializer chip that can provide diagnostic information. There is an internal timer that rotate which of the subscribed channels that are sent to the deserializer chip. It will provide information about video resolution detected, if it complies with the an SDI video standard and checking for signal faults like check-sum (CRC).

Outputs

Configure the signal output ports.

Each output port represent one row in the table.



Name	Label	Automatic Changeover	Port Reclocker	Port Cable Driver	Sync Source
SFP #1	Output port 1	Disabled	Rate: Auto	Unlocked	No sync
SFP #2	Output port 2	Disabled	Rate: Auto	Unlocked	No sync
SFP #3	Output port 3	Disabled	Rate: Auto	Unlocked	No sync
SFP #4	Output port 4	Disabled	Rate: Auto	Unlocked	No sync
SFP #5	Output port 5	Disabled	Rate: Auto	Unlocked	No sync

- **Name:** This name of the port is matching the silk print on the front of the BTF1-XX.
- **Label:** This name you may change as you may wish.
- **Groups:** If you want to have grouping of ports in the Matrix tab, you can prefix each label with the name of the group and add a \.



Name	Label
SFP #1	R1\DVD player
SFP #2	R1\PC
SFP #3	R1\Ani player
SFP #4	R1\Input port 4



- **Port reclocker:** Each output port features a SDI re-clocker chip that can re-clock SD (270M), HD (1.5G) and 3G data rates. Each port can be forced to 'Bypassed', 'Power down' or leave at 'Auto'. In most circumstances, it is safe to leave this at Auto for non-SDI signals as well.

Examples:

ASI: will be re-clocked as SD-SDI

SDTI: will be re-clocked as HD-SDI or 3G-SDI

Ethernet: will be automatically be bypassed

- **Port Cable Driver:** The BNC ports features a port cable driver that can be fine-tuned here. For SFP ports, you can see if the SFP is inserted and the status of the TX disabled parameter.
 - * **Speed:** Adjust the rise and fall time of the signal. For signals above SD (270M) data rate HD should be selected.
 - * **Output swing:** The output voltage of the signal can be adjusted here. Normally it should be 800mV.
 - * **Direction:** Changes the signal direction for this BNC port. Each port can be defined to be either an input or an output.
- **Sync Source:** You can select if a given output signal is going to have a reference or not. The reference is only used when changing the signal source for this given destination. If you have selected a source and it is not valid; the change will still happen, but will be delayed approx. 50ms before the change is forced.

Signal redundancy switch

As a great-added functionality of Barnfind’s latest release, an integrated signal redundancy switch can be configured to all the BarnOne’s outputs.

Regardless of signal format, bandwidth, optical or electrical; each individual output can be configured with “alternative” inputs, and they all run in parallel individuality.

The change-over function is activated by 3 different validations:

- *Signal LOS*
- *signal analyzer Lock (SDI only)*
- *signal analyzer errors (SDI only)*

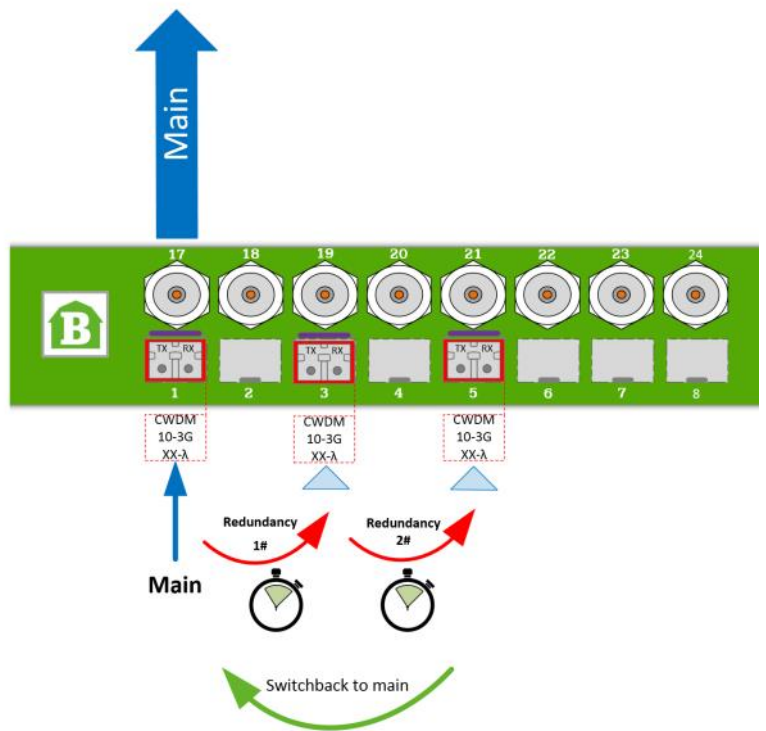

Barnfind’s Redundancy Switch functionality gives the user full control of signal presence, quality and status. From being a simple converter/router/ distributor, the range of BarnOne frames have transformed to be a complex and advanced redundancy system. Even with this complexity, the redundancy functions can easily be configured and monitored in the new released BarnStudio web interface.



Press this button to access the redundancy configuration table.

Operation Mode - Enable/Disable the redundancy switch function for the selected output.

Status - Normal/Degraded

- Normal shows when output is connected to Main signal.
- Degraded shows when output is rerouted to one of the backup inputs.

Timeout (ms) - Select how many milliseconds before switch will activate.

Switchback to main - Enable/Disable a switchback to main signal if main recover.

Switchback timeout (ms) - Select how many milliseconds before switch back to main if it recover (to prevent from toggeling if main is unstable)

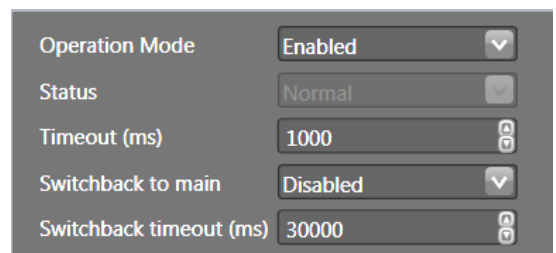

The list will display all inputs available in the BarnOne frame. Select if input should be **Main** or Backup.

Note, you can use multiple main or backup inputs. The priority is the input numer

Name	Enabled	Sensitive to LOS	Sensitive to analyzer lock	Sensitive to analyzer errors
SFP #1: Input port 1	Main	<input type="checkbox"/>	<input type="checkbox"/>	<input type="checkbox"/>
SFP #2: Input port 2	(not used)	<input type="checkbox"/>	<input type="checkbox"/>	<input type="checkbox"/>
SFP #3: Input port 3	Backup	<input type="checkbox"/>	<input type="checkbox"/>	<input type="checkbox"/>
SFP #4: Input port 4	(not used)	<input type="checkbox"/>	<input type="checkbox"/>	<input type="checkbox"/>
SFP #5: Input port 5	Backup	<input type="checkbox"/>	<input type="checkbox"/>	<input type="checkbox"/>
SFP #6: Input port 6	(not used)	<input type="checkbox"/>	<input type="checkbox"/>	<input type="checkbox"/>
SFP #7: Input port 7	(not used)	<input type="checkbox"/>	<input type="checkbox"/>	<input type="checkbox"/>
SFP #8: Input port 8	(not used)	<input type="checkbox"/>	<input type="checkbox"/>	<input type="checkbox"/>
SFP #9: Input port 9	(not used)	<input type="checkbox"/>	<input type="checkbox"/>	<input type="checkbox"/>
SFP #10: Input port 10	(not used)	<input type="checkbox"/>	<input type="checkbox"/>	<input type="checkbox"/>
SFP #11: Input port 11	(not used)	<input type="checkbox"/>	<input type="checkbox"/>	<input type="checkbox"/>

The change-over function is activated by 3 different validations:

- *Signal LOS*
- *SDI analyzer lock*
- *SDI analyzer errors*

No signal detected at input.

Signal analyzer does not verify the signal as a valid SDI signal.

Signal has too many errors (jitters) and will not be verified as a valid signal.

Possible cause

Broken fiber/coax cable. Signal source missing.

Signal source changed to «unknown» format, not SD, HD or 3G-SDI.

Poor cable/connectors.

Note! The two functions *Sensitive to analyzer lock* and *Sensitive to analyzer errors* should not be used with other than SDI signals

AA-MADI - MADI-Router with analog interfaces (only available for BTF1-10AA)

A 264x264 channel audio matrix interfaces to the main matrix with 4 bi-directional MADI connections and 8 balanced analog line level inputs and outputs. The board offers single channel routing for all 4 MADI streams and the 8 analog ports.

Setup:

The *Setup* tab gives a quick overview of all incoming and outgoing signals. *MADI#25* to *MADI#28* are incoming MADI streams from the main matrix. *MADI#25 return* to *MADI#28 return* are MADI outputs from the audio matrix returning to the main matrix. Green, red or black lines indicate *valid*, *invalid* or *no signal*. The

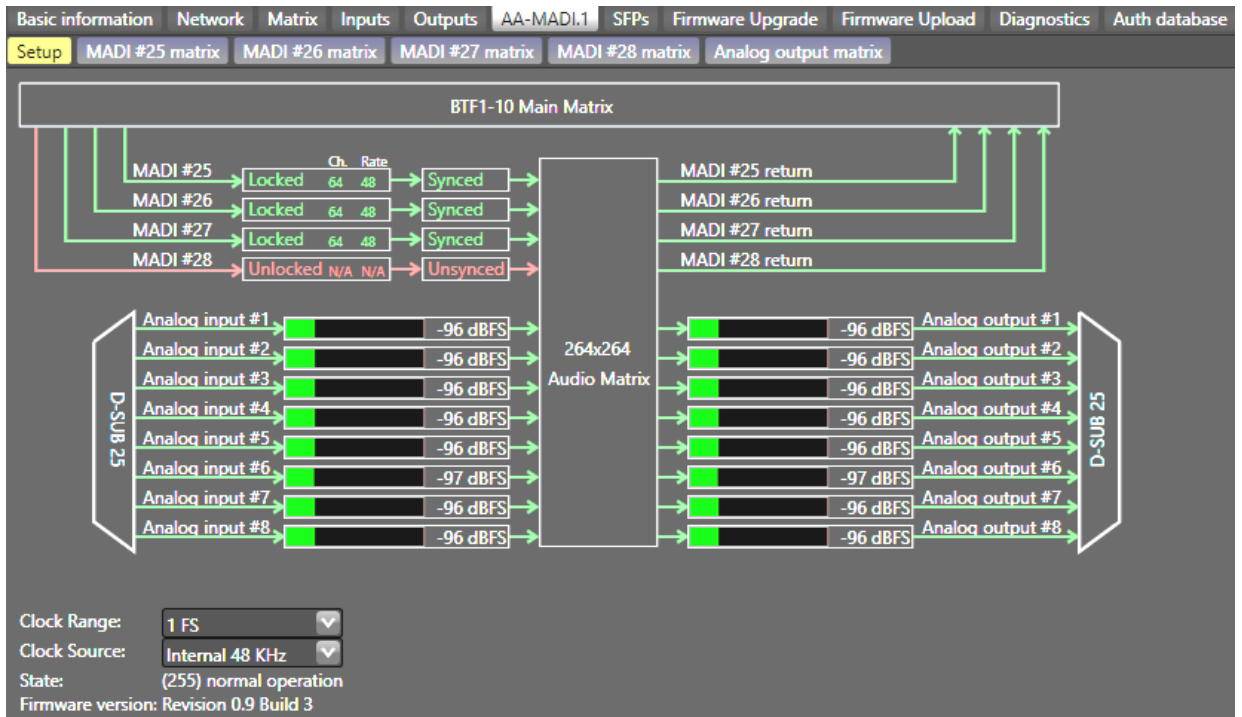

channel count (56 or 64 channels per MADI) and the sampling rate as well as the sync status are indicated. The returning MADI stream should always be green, the board always generates valid MADI (AES10) signals at it's outputs.

You will find a digital level meter for each single channel for analog input and output channels.

Clock Setup

While the top part of the *Setup* tab is for monitoring purposes only, at the bottom of the tab you will find two drop down menus for clock setup. All MADI streams which connect to the board need to synchronise to the same clock. As a clock source any of the 4 MADI inputs can be used, or you can choose to clock the board internally.

Sampling Rates

Available sampling rates are 44.1kHz and 48kHz, 88.2kHz and 96kHz are supported by S/MUX. The scaling factor is selected by the drop down menu *Clock Range*, while the selection of the sampling rate for each MADI output is to be found in the tabs *MADI #25 matrix* to *MADI #28 matrix*.

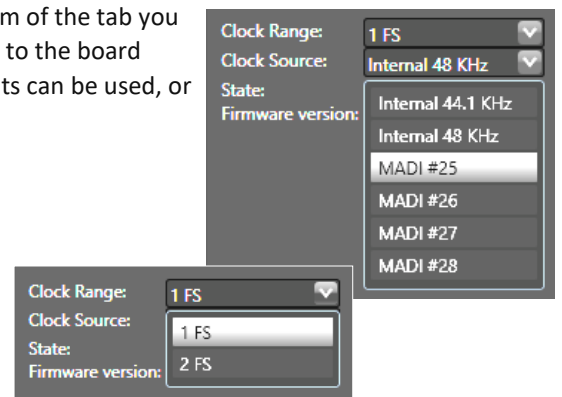

Audio Routing:

For the 4 MADI interfaces connecting to the main matrix and the eight analog line level interfaces there is an output based routing matrix which is separated into 5 different tabs, one for each MADI output and one for the analog outputs. The unusual numeration of the MADI inputs and outputs (25-28) arises from the port numbers in the main matrix of the BTF1-10AA frame, where the 4 MADI ports have the fix port numbers 25-28.

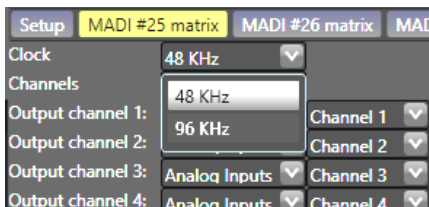
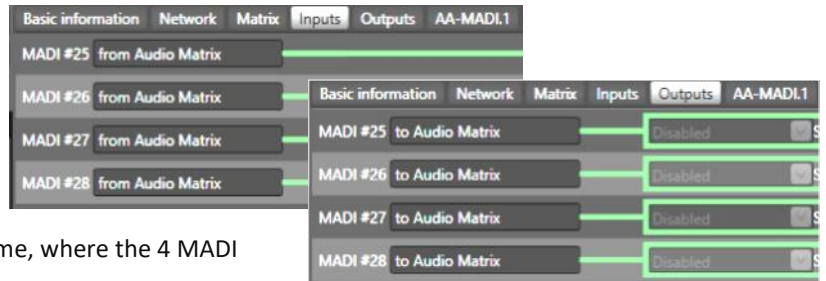

Clock selects the sampling rate for this particular MADI output, 48kHz or 96kHz

Channels selects whether the MADI is operating in 56 or 64 channel mode

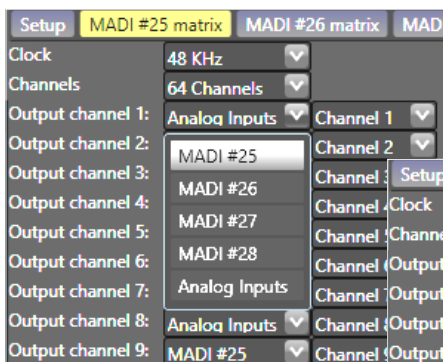
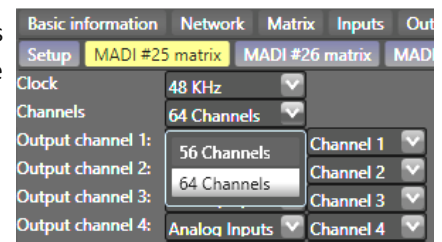

For each single **Output channel** you can individually select the source (analog input or MADI#25 - #28)

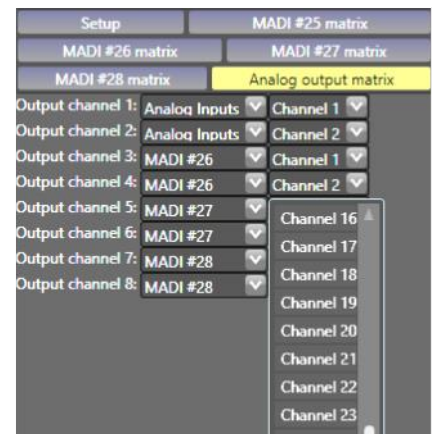
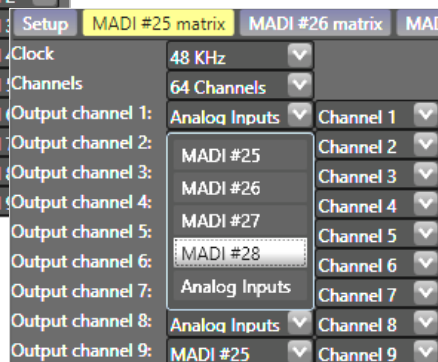

After selecting the source for the output, you select one of the channels (1-64) of that source, which is routed to this particular output channel.

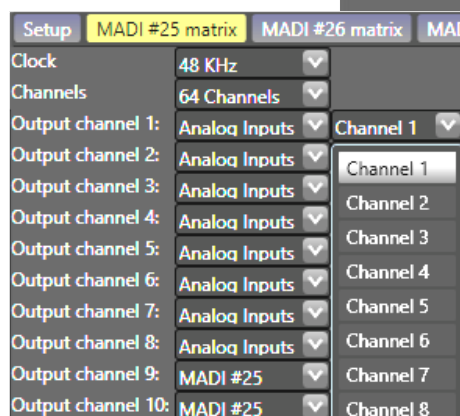

SFPs

Monitor each SFP inside the BTF1-XX frame.

Basic information													Network	Matrix	Inputs	Outputs	SFPs	Firmware Upgrade	Firmware Upload	Diagnostics	Auth database	
PortName	Vendor	PartNumber	SerialNumber	Production Date	WaveLength	Bitrate	SM	OM1	OM2	OM3	Copper	Connector										
SFP #1	BarnFind Tech	BTSFP-LX-SM-3G02	607281240120	2016-8-8	1310	3 GHz	2000 m	0 m	0 m	0 m	0 m	LC										
SFP #2	EMBRIONIX	EB34TD1R-SM	114060300022	2015-5-7 CG	0	3 GHz	0 m	0 m	0 m	0 m	4 m	HDMI Type D										
SFP #3	EMBRIONIX	EB34TD1R-SM	114060300017	2014-6-11 CG	0	3 GHz	0 m	0 m	0 m	0 m	4 m	HDMI Type D										
SFP #4					0	N/A	0 m	0 m	0 m	0 m	0 m											
SFP #5	BarnFind Tech	BT-CWDM-10-3G37	612131240115	2017-2-10	1370	3 GHz	10000 m	0 m	0 m	0 m	0 m	LC										
SFP #6	BarnFind Tech	BT-CWDM-10-3G38	702241240005	2017-3-15	1390	3 GHz	10000 m	0 m	0 m	0 m	0 m	LC										
SFP #7	BarnFind Tech	BT-CWDM-10-3G41	612131240172	2017-2-10	1410	3 GHz	10000 m	0 m	0 m	0 m	0 m	LC										
SFP #8	BarnFind Tech	BT-CWDM-10-3G43	612221240010	2017-2-7	1430	3 GHz	10000 m	0 m	0 m	0 m	0 m	LC										
SFP #9					0	N/A	0 m	0 m	0 m	0 m	0 m											
SFP #10					0	N/A	0 m	0 m	0 m	0 m	0 m											
SFP #11					0	N/A	0 m	0 m	0 m	0 m	0 m											
SFP #12					0	N/A	0 m	0 m	0 m	0 m	0 m											
SFP #13					0	N/A	0 m	0 m	0 m	0 m	0 m											
SFP #14					0	N/A	0 m	0 m	0 m	0 m	0 m											
SFP #15					0	N/A	0 m	0 m	0 m	0 m	0 m											
SFP #16	EMBRIONIX	EB34TD1T-SM	115012900029	2015-2-2 CE	0	3 GHz	0 m	0 m	0 m	0 m	3 m	HDMI Type D										

Port Name: Name as given on the silk screen on the front of the BTF1-XX frame.

Vendor: The manufacturer brand for this SFP.

Part Number: the part number for this SFP.

Serial Number: The serial number for this SFP.

Production Date: The production date for this SFP.

Wave Length: This is the wave length of the TX (transmitter) if this is a fiber SFP if applicable. This is a good feature if you operate with CWDM or WDM (BiDi) SFPs.

Bitrate: The designed maximum bitrate for the SFP.

SM: The designed operation length for single-mode fiber.

OM 1, OM 2 and OM 3: The designed operation length for multi-mode fiber.

Copper: The designed operation length for copper cables.

Connector: Display the connector that the SFP has.

Name	Value
RX LOS	<input checked="" type="checkbox"/>
RX Power dBm	-36,99 dBm
RX Power mW	0,0002 mW
Temperature	43 C
TX Bias	10,656 mA
TX Disable	<input type="checkbox"/>
TX Fault	<input type="checkbox"/>
TX Power	0,7063 mW
TX Power dBm	-1,51 dBm
Vcc	3,1344 V

Depending on what SFP you have selected by clicking on any SFP in the overview, it will appear in the bottom table with more diagnostical information about that particular SFP.

Note1, this is an excellent tool to verify if the optical signal is within a valid range.

Note2, a value close to -40 dBm will appear (p.ex. -36,99dBm) if the optical signal is missing, or too high. Read the SFP data sheet to find the Rx overload limit (max power)

Name	Value
RX LOS	<input checked="" type="checkbox"/>
RX Power dBm	-36,99 dBm
RX Power mW	0,0002 mW

Firmware upgrade (online mode)

The purpose of this section is to see the versions of the firmware that is installed, check for new versions and to upgrade the firmware at your convenience. For this purpose the frame needs to connect to the internet.

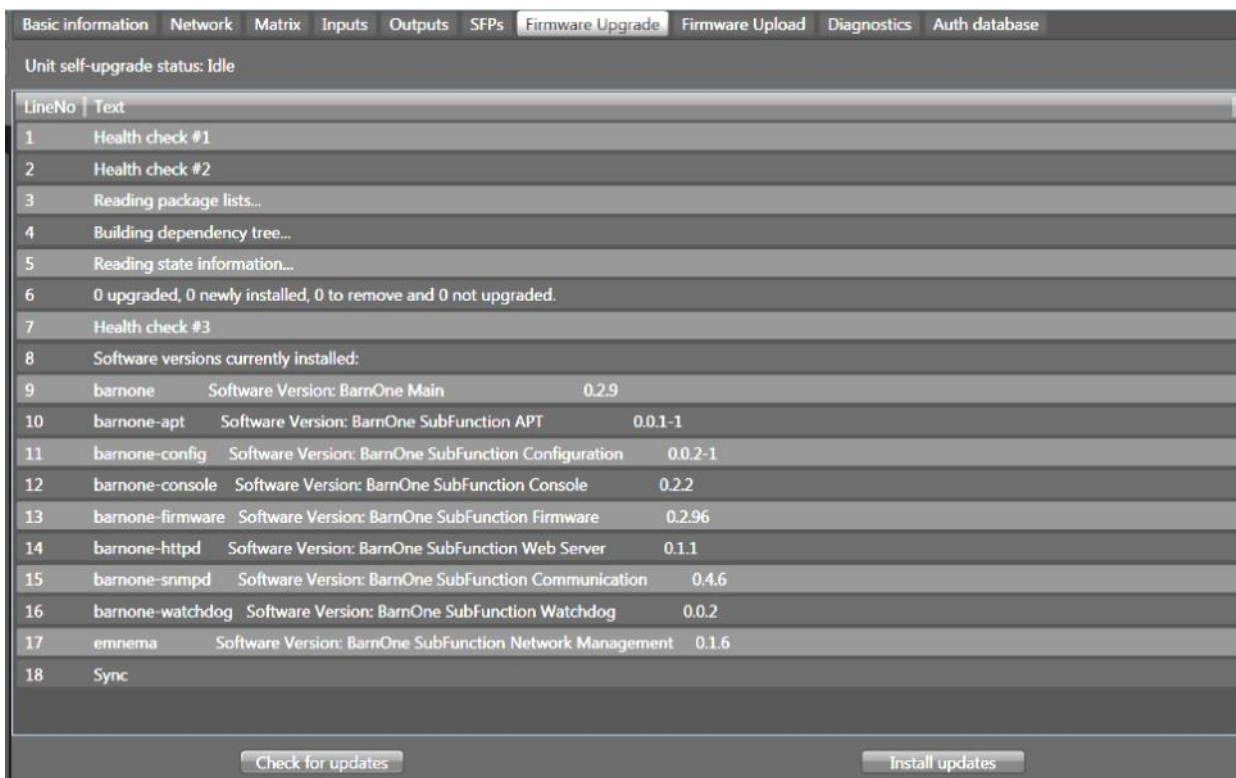

Unit self-upgrade status: Idle

LineNo	Text
1	Health check #1
2	Health check #2
3	Reading package lists...
4	Building dependency tree...
5	Reading state information...
6	0 upgraded, 0 newly installed, 0 to remove and 0 not upgraded.
7	Health check #3
8	Software versions currently installed:
9	barnone Software Version: BarnOne Main 0.2.9
10	barnone-apt Software Version: BarnOne SubFunction APT 0.0.1-1
11	barnone-config Software Version: BarnOne SubFunction Configuration 0.0.2-1
12	barnone-console Software Version: BarnOne SubFunction Console 0.2.2
13	barnone-firmware Software Version: BarnOne SubFunction Firmware 0.2.96
14	barnone-httpd Software Version: BarnOne SubFunction Web Server 0.1.1
15	barnone-snmpd Software Version: BarnOne SubFunction Communication 0.4.6
16	barnone-watchdog Software Version: BarnOne SubFunction Watchdog 0.0.2
17	emnema Software Version: BarnOne SubFunction Network Management 0.1.6
18	Sync

Check for updates Install updates

- **Check for Updates:** This button will trigger the frame BTF1-XX to connect to our server at Barnfind Technologies HQ in Norway and check for software updates. You can see the progress in the log and the status label.
- **Install Updates:** This button will trigger the frame BTF1-XX to download from Barnfind Technologies HQ in Norway and install the newest software updates. You can see the progress in the log and the status label.

Firmware upload (offline mode)

Instead of connecting the frame via the internet to Barnfind’s server, you can download the latest firmware from the Support/Download section at our website <https://www.barnfind.no/downloads/>



The screenshot shows a web interface with a navigation bar containing: Basic information, Network, Matrix, Inputs, Outputs, SFPs, Firmware Upgrade, **Firmware Upload**, Diagnostics, and Auth database. Below the navigation bar, the current upload status is 'Idle'. A section titled 'Last upload execute log:' contains the following text:

```
Removing 'diversion of /boot/overlays/spi0-hw-cs.dtbo to /usr/share/rpikernelhack/overlays/spi0-hw-cs.dtbo by rpikernelhack'
Removing 'diversion of /boot/overlays/spi1-1cs.dtbo to /usr/share/rpikernelhack/overlays/spi1-1cs.dtbo by rpikernelhack'
Removing 'diversion of /boot/overlays/spi1-2cs.dtbo to /usr/share/rpikernelhack/overlays/spi1-2cs.dtbo by rpikernelhack'
Removing 'diversion of /boot/overlays/spi1-3cs.dtbo to /usr/share/rpikernelhack/overlays/spi1-3cs.dtbo by rpikernelhack'
Removing 'diversion of /boot/overlays/spi2-1cs.dtbo to /usr/share/rpikernelhack/overlays/spi2-1cs.dtbo by rpikernelhack'
Removing 'diversion of /boot/overlays/spi2-2cs.dtbo to /usr/share/rpikernelhack/overlays/spi2-2cs.dtbo by rpikernelhack'
Removing 'diversion of /boot/overlays/spi2-3cs.dtbo to /usr/share/rpikernelhack/overlays/spi2-3cs.dtbo by rpikernelhack'
Removing 'diversion of /boot/overlays/tinylcd35.dtbo to /usr/share/rpikernelhack/overlays/tinylcd35.dtbo by rpikernelhack'
Removing 'diversion of /boot/overlays/uart1.dtbo to /usr/share/rpikernelhack/overlays/uart1.dtbo by rpikernelhack'
Removing 'diversion of /boot/overlays/vc4-fkms-v3d.dtbo to /usr/share/rpikernelhack/overlays/vc4-fkms-v3d.dtbo by rpikernelhack'
Removing 'diversion of /boot/overlays/vc4-kms-v3d.dtbo to /usr/share/rpikernelhack/overlays/vc4-kms-v3d.dtbo by rpikernelhack'
Removing 'diversion of /boot/overlays/vga666.dtbo to /usr/share/rpikernelhack/overlays/vga666.dtbo by rpikernelhack'
Removing 'diversion of /boot/overlays/w1-gpio-pullup.dtbo to /usr/share/rpikernelhack/overlays/w1-gpio-pullup.dtbo by rpikernelhack'
Removing 'diversion of /boot/overlays/w1-gpio.dtbo to /usr/share/rpikernelhack/overlays/w1-gpio.dtbo by rpikernelhack'
Removing 'diversion of /boot/overlays/wittypi.dtbo to /usr/share/rpikernelhack/overlays/wittypi.dtbo by rpikernelhack'
Processing triggers for ca-certificates ...
Updating certificates in /etc/ssl/certs... 171 added, 0 removed; done.
Running hooks in /etc/ca-certificates/update.d...done.
Complete
```

Below the log is a section titled 'Upload file progress log:' with the following text:

```
Initiating upload of Z:\Dokumente\Arbeit\Barnfind\Software\firmware-2017-06-14-0.2.11\autorun.gpg
Sent 58045257 of 58045257 bytes
Waiting for last ACK
Complete
```

At the bottom of the interface are two buttons: 'Upload file' and 'Cancel upload'.

 autorun.gpg	14.06.2017 13:36
 barnone-passwordreset-0.2.11	14.06.2017 13:44
 README	14.06.2017 13:44

«autorun.gpg» contains the firmware and has to be selected for upload to the frame

«barnone-passwordreset.zip» contains another autorun.gpg file, that can reset the password of the frame in case you lost/ forgot the password.

Firmware upgrade with USB stick (offline mode)

After downloading the firmware upgrade package from our website <http://www.barnfind.no/downloads/> extract the `autorun.gpg` from the .zip file and copy this file onto a USB flash storage device (see Firmware Upload, you use the same file). This file must be named "autorun.gpg" (lower case).

To monitor the upgrade process, you can connect a HDMI display to the HDMI output at the rear of the BarnOne device and a keyboard to one of the USB ports (this is not essential for the upgrade process). If screen is blank, press any key to wake the display up from sleep. Insert the USB flash storage containing "autorun.gpg" into a USB port on the BarnOne device. In the next 10-20 seconds, the BarnOne device will copy the `autorun.gpg` and verify its content against a cryptographical key. If this goes ok, the software upgrade will start.

The LED lights will start to blink in a special pattern to show that it is performing the software upgrade. The USB flash storage should now be removed. If the USB flash storage is present after software upgrade is complete, the BarnOne device might start to copy the `autorun.gpg` file and perform the software upgrade again. When the LED lights stop blinking, the software upgrade is complete and device will return to normal operation.

It is estimated that the software upgrade normally takes about 5 minutes if all of the software components are to be upgraded.



USB for upgrade



Diagnostics

The purpose of this section is to see the generic health and diagnostics of the BTF1-XX frame. Each individual diagnostic entry is represented with a line in the table.

Basic information			Network			Matrix			Inputs			Outputs			SFPs			Firmware Upgrade			Firmware Upload			Diagnostics			Auth database		
Name												Value			Send to frontpanel LED														
Analog reference sync												0 FPS			<input type="checkbox"/>														
BIT, left topboard BNC, U31: Reclocker port 01-04 PLL unlocked												0 / 1			<input checked="" type="checkbox"/>														
BIT, left topboard BNC, U31: Reclocker port 01-04 Reference missing												0 / 1			<input checked="" type="checkbox"/>														
BIT, left topboard BNC, U32: Reclocker port 05-08 PLL unlocked												0 / 1			<input checked="" type="checkbox"/>														
BIT, left topboard BNC, U32: Reclocker port 05-08 Reference missing												0 / 1			<input checked="" type="checkbox"/>														
BIT, mainboard, U30: Reclocker port 01-04 PLL unlocked												0 / 1			<input checked="" type="checkbox"/>														
BIT, mainboard, U30: Reclocker port 01-04 Reference missing												0 / 1			<input checked="" type="checkbox"/>														
BIT, mainboard, U31: Reclocker port 05-08 PLL unlocked												0 / 1			<input checked="" type="checkbox"/>														
BIT, mainboard, U31: Reclocker port 05-08 Reference missing												0 / 1			<input checked="" type="checkbox"/>														
BIT, mainboard, U33: Reclocker port 09-12 PLL unlocked												0 / 1			<input checked="" type="checkbox"/>														
BIT, mainboard, U33: Reclocker port 09-12 Reference missing												0 / 1			<input checked="" type="checkbox"/>														
BIT, mainboard, U34: Reclocker port 13-16 PLL unlocked												0 / 1			<input type="checkbox"/>														
BIT, mainboard, U34: Reclocker port 13-16 Reference missing												0 / 1			<input checked="" type="checkbox"/>														
BIT, right topboard BNC, U31: Reclocker port 01-04 PLL unlocked												0 / 1			<input checked="" type="checkbox"/>														
BIT, right topboard BNC, U31: Reclocker port 01-04 Reference missing												0 / 1			<input checked="" type="checkbox"/>														
BIT, right topboard BNC, U32: Reclocker port 05-08 PLL unlocked												0 / 1			<input checked="" type="checkbox"/>														
BIT, right topboard BNC, U32: Reclocker port 05-08 Reference missing												0 / 1			<input checked="" type="checkbox"/>														
Cabinet fan #1												7741 RPM			<input checked="" type="checkbox"/>														
Cabinet fan #2												7619 RPM			<input checked="" type="checkbox"/>														
Cabinet fan #3												7868 RPM			<input checked="" type="checkbox"/>														
Cabinet fan #4												7868 RPM			<input checked="" type="checkbox"/>														
Fan controller temperature #1												40 C			<input checked="" type="checkbox"/>														
Fan controller temperature #2												39 C			<input checked="" type="checkbox"/>														
MCU temperature												25 C			<input checked="" type="checkbox"/>														
Power-1 input voltage												0 V			<input type="checkbox"/>														
Power-2 input voltage												12,2 V			<input checked="" type="checkbox"/>														

- A yellow frame will appear when the value is above the **warning** threshold.
- A red frame will appear when the value is above the **error** threshold.

Power-1 input voltage	0 V	<input type="checkbox"/>
Power-2 input voltage	12,2 V	<input checked="" type="checkbox"/>

Send to front panel LED : If this is checked; a warning or an error will activate the blue alarm-LED on the front of the BTF1-XX to flash.

Authentication Database

User Right Management with three different user levels for future usage...

Basic information						Network		Matrix		Inputs		Outputs		SFPs	
Firmware Upgrade				Firmware Upload				Diagnostics				Auth database			
Id	Username			Real name			AccessLevel								
1	admin						Administrator								
2	per						Guest								
3	stian						Guest								
4	arild						Guest								

BarnMini-05

BarnMini-05 is the only software controlled device in the BarnMini product line. It supports TSL Tally and TSL UMD protocols and can be used to transport GPIO and RS422/RS485 control signals over fiber. It converts 1x RS422/RS485 and up to 4x GPI and up to 4x GPO to Ethernet. This Ethernet signal is available at the SFP port. The same SFP port is used for configuration of BarnMini-05. You need BTSFP-GBase-CU to connect BarnMini-05 to a Ethernet switch or directly to your PC. Once configured you can use any optical SFP in the slot to send the signals over fiber, or you can use the electrical SFP to connect BarnMini-05 to an Ethernet switch and cascade several BarnMini-05 devices to rise the channel count of GPIO or RS422/RS485 signals.

To connect to BarnMini-05 please follow the steps described in following pages. It will appear as a device in the device list of BarnStudio.

The screenshot displays the BarnStudio configuration interface for a BarnMini-05 device. The top navigation bar includes tabs for 'Basic information', 'Network', 'Serial UART', 'GPIO', 'UMD v4.0 Server', 'UMD V4.0 Clients', 'TSL Tally Server', 'TSL Tally Clients', and 'Firmware Upload'. The 'Basic information' tab is active, showing details like Model (BARNMINI-05), Serial Number, Network ID, and Firmware Version. Below this, there are fields for 'sysName' and 'sysLocation', both set to 'BarnMini-05'. A 'Telnet connection properties' section is visible on the left, including fields for Username, Password, and Force Host/Port. The main configuration area is divided into 'Network Status' and 'Network Configuration'. 'Network Status' shows the IP configuration as 192.168.0.127/24 and the route as 'via 192.168.0.1 dev st'. 'Network Configuration' is split into IPv4 and IPv6 sections, each with radio buttons for DHCP/BOOTP, Disabled, LinkLocal, and Static. Below these are input fields for IP addresses, Default Gateway, DNS servers, and DNS searches. At the bottom, there are buttons for 'Download configuration from device' and 'Upload configuration to device'. A log window at the very bottom shows the message: 'Initiate download Issuing a download from the device using the native driver Downloaded network configuration successfully from the device'.



Serial Control Data Settings

On the tab «Serial UART» you find all settings for the transport of RS422 or RS485 serial control data. Please check the manual of the device you want to control for *Baudrate*, *Parity*, *Stop Bits* and *Operation Mode*.

If you connect 2 BarnMini-05 units to transport serial control data, select one device to act as server and the other one to be the client. It does not matter which unit is the server and which one is the client. The client will connect to the server once you entered the server's IP address in the field *Host*.

The standard port is 2167

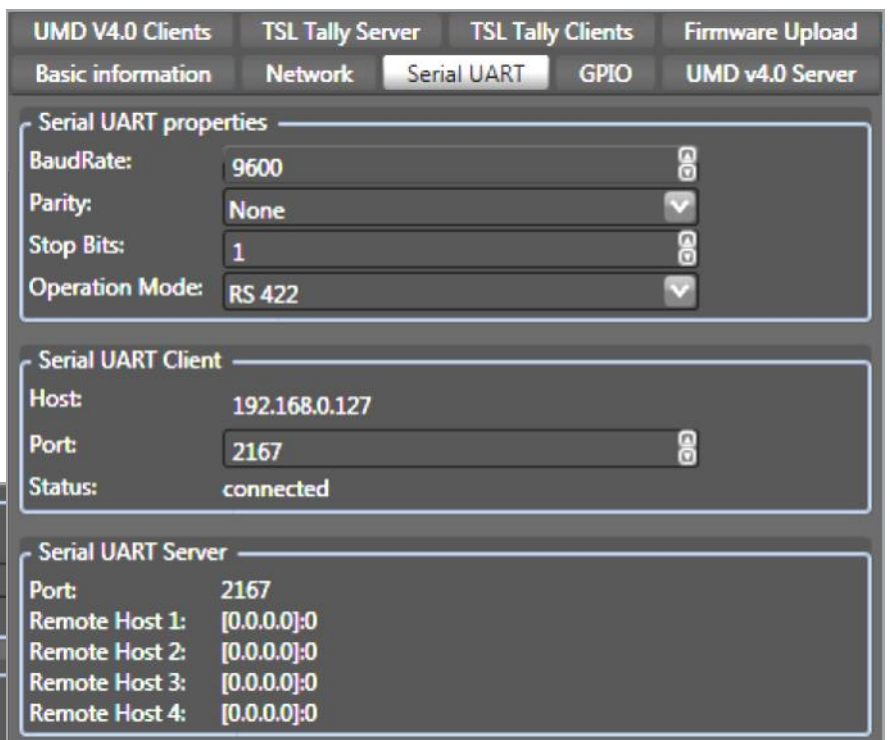
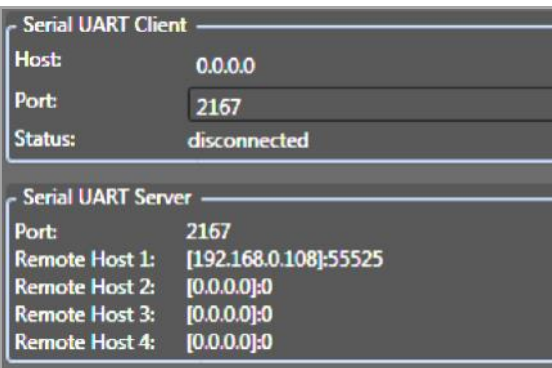

GPIO Transport

The GPIO tab shows the status of the GPI and GPO ports.

You can manually switch the GPOs. If the GPOs are remotely controlled by a client, they will switch back to the status which is pushed by the client. If no client is pushing data to the BarnMini-05 GPO host, you can manually switch the GPOs with BarnStudio.

You can select, if the LEDs placed beside the RJ45 connectors show the status of GPIs or GPOs.

To transport GPI signals from one BarnMini-05 to GPO ports of another BarnMini-05 you can use TSL Tally protocol or TSL UMD protocol:

GPIO via TSL UMD protocol

Select the tab *UMD v4.0 Clients* on the BarnMini-05 unit which receives the GPI signals at the RJ45 connector. You can configure 4 different clients, to push data to 4 different host/servers.

Enter the IP address of the BarnMini-05 unit which outputs the GPO signals at the RJ45 connector under *Remote Host*. You can select the transport protocol UDP or TCP. For UDP the standard port is 8900, for TCP it is port 8910. Now select which GPI signal from the RJ45 connector will be pushed to the network as *Tally Output1* to *Tally Output4*. The *Tally Outputs* can be assigned to a display number from 0-126 and the brightness can be set to values 0, 1/7, 1/2 and 1.

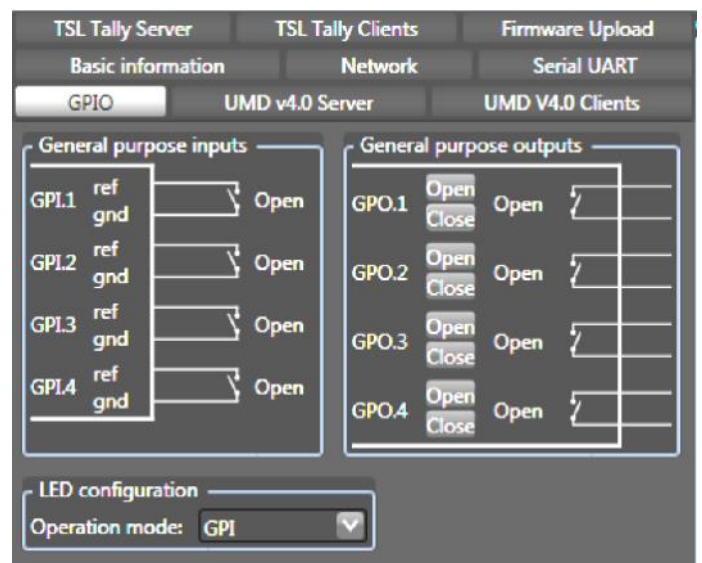

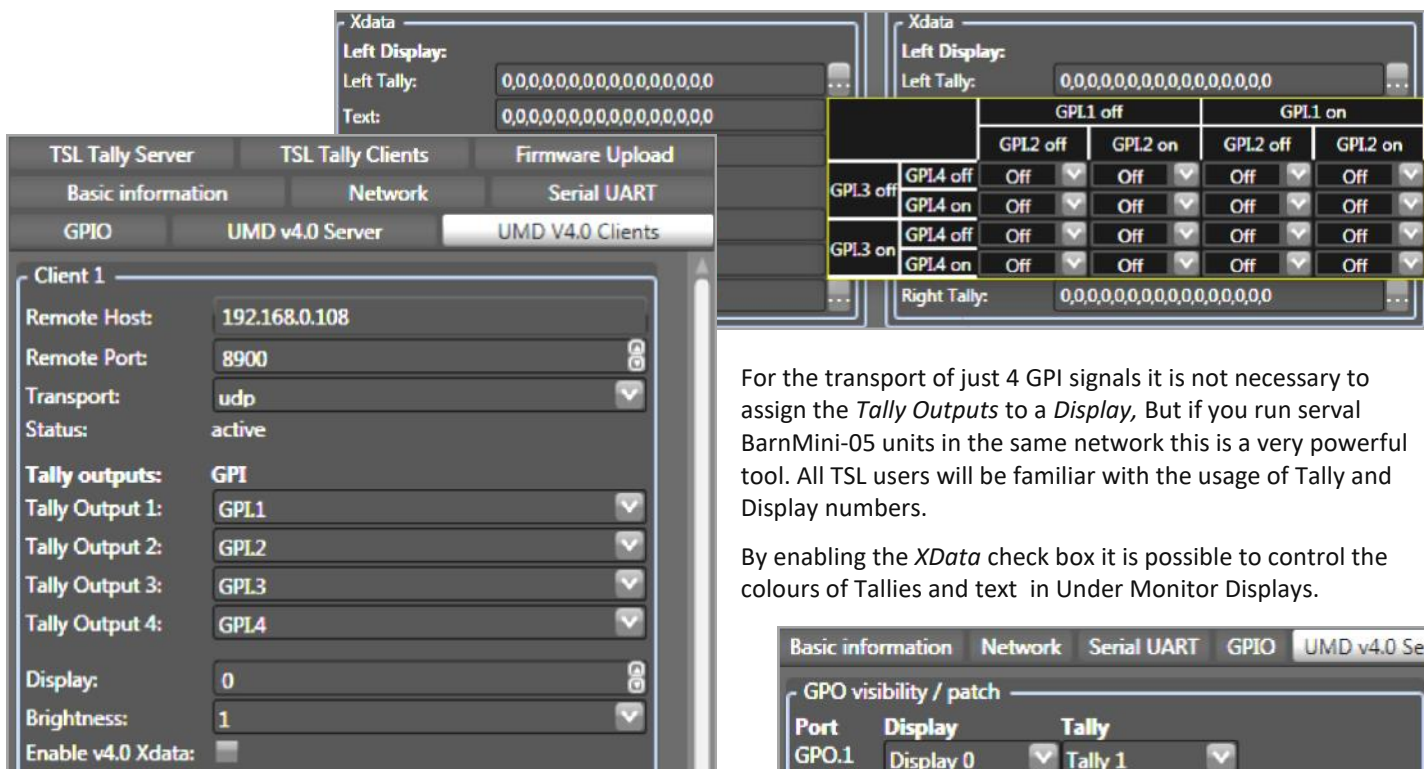

For the transport of just 4 GPI signals it is not necessary to assign the Tally Outputs to a Display, But if you run several BarnMini-05 units in the same network this is a very powerful tool. All TSL users will be familiar with the usage of Tally and Display numbers.

By enabling the XData check box it is possible to control the colours of Tallies and text in Under Monitor Displays.

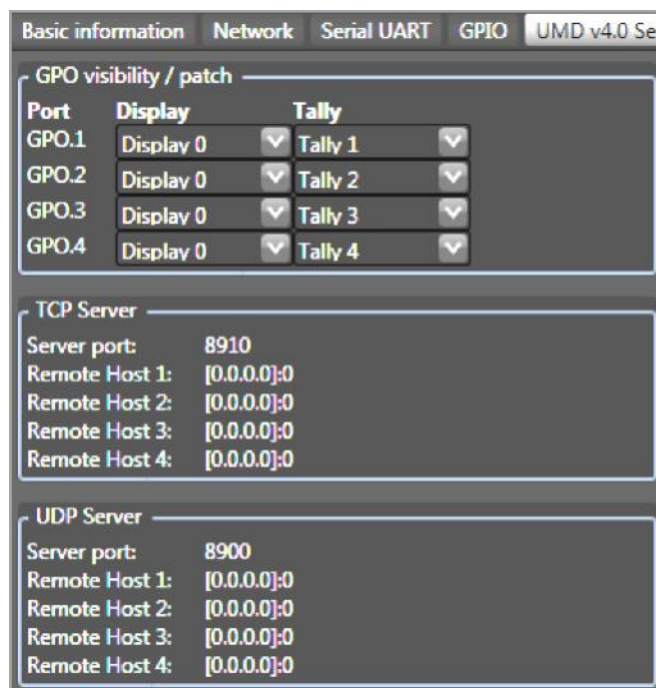

To configure the output ports or the GPOs, select the UMD v4.0 Server tab of the BarnMini-05 unit which shall output the GPOs. Under TCP Server or UDP Server you can see the active client which is pushing Tally signals to this server/host. Select the Display No. and Tally No. for each GPO port.

BarnMini-05 can be configured to receive Tally signals from 8 different clients at the same time. 4 of the clients will have to use TCP protocol, the 4 other clients should use UDP protocol. You as a user can now play Ping Pong with the GPO outputs.

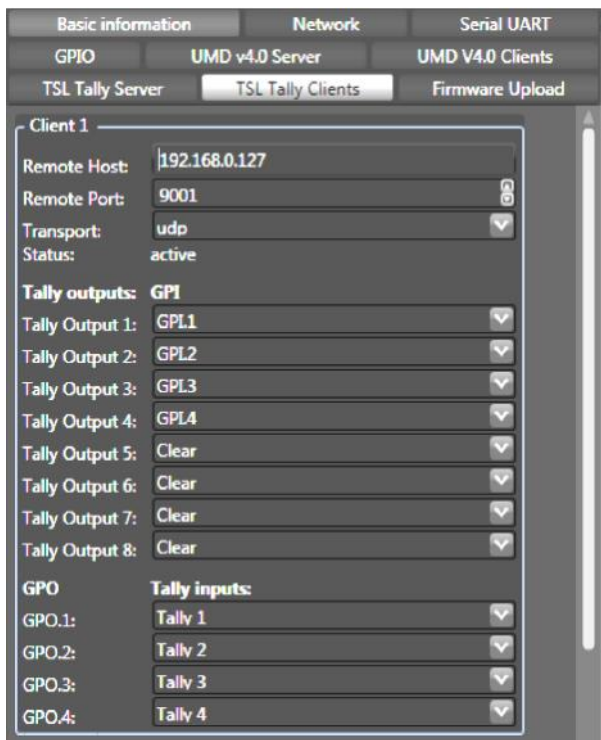

GPIO via TSL Tally protocol

An easier way to configure GPI transport is via TSL Tally protocol.

Select one BarnMini-05 of a pair to be the client. Enter the IP address of the BarnMini-05 unit which you want to push the GPI to under Remote Host. The standard port for the transport via UDP protocol is 9001, for the transport via TCP is 8001. Once you entered the IP and the host/server is available on the network, the status will show «active»

Now you can select which GPI signal 1-4 from the RJ45 connectors is pushed to the network as Tally Output 1-8. Below you select which GPO port at the RJ45 connectors outputs which of the Tallies 1-8.



The tab *TSL Tally Server* shows you the connected TSL Tally clients and which protocol is used (UDP or TCP).

Select the *Tally Output 1-8* and assign it to the physical *GPO 1-4* at the RJ45 connector.

For each *Tally Input 1-8* which are pushed to the network you can select a physical input port *GPI 1-4*. It is possible to assign one physical *GPI* ports to several *Tally* channels

Automatically trigger a change over switch (e.g. BarnMini-06)

You can configure BarnMini-05 to automatically trigger e.g. a BarnMini-06 to change over to the redundant fiber strand by GPO.

On the tab *Ping Clients* enter the IP address of any device which is physically located at the other end of the fiber but connected to the same network as Barnmini-05 into thne field *Remote Host*. BarnMini-05 immediately starts to ping the host and tells the *Status*, *Average Response Time* and *Error Count*.

Choose which GPO port you want to react to a loss of the remote host and how to react:

- *close on online*
- *close on offline*
- *toggle while offline detected*

Select the *Interval* between each ping (50-2000ms)

Select the *Timeout* for each ping (min. 5ms; max 4xvalue of *Interval*)

Select the *Error Count Limit* before *Status* is detected as *offline*

Toggle cooldown: If GPO is set to *toggle*, how long to wait in ms if the host went offline before the detection logic restarts. This is to avoid the relay to bounce fast if offline status is detected (min 50ms; max. 60000ms).

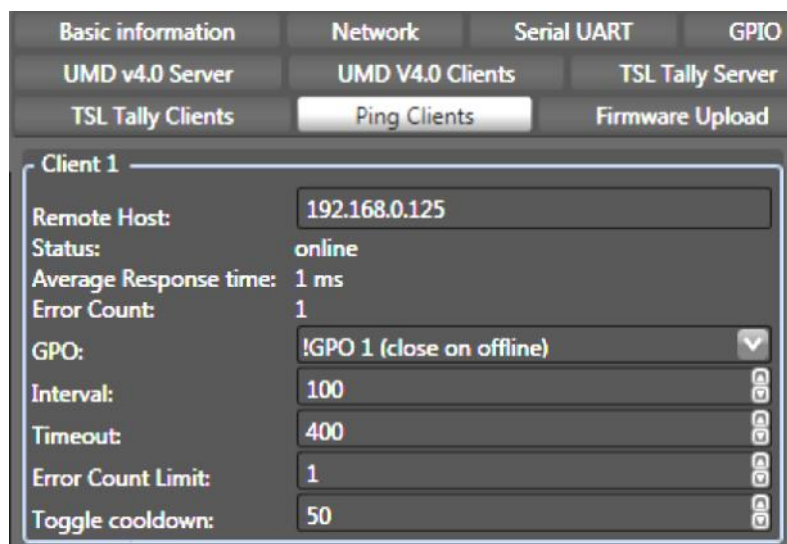
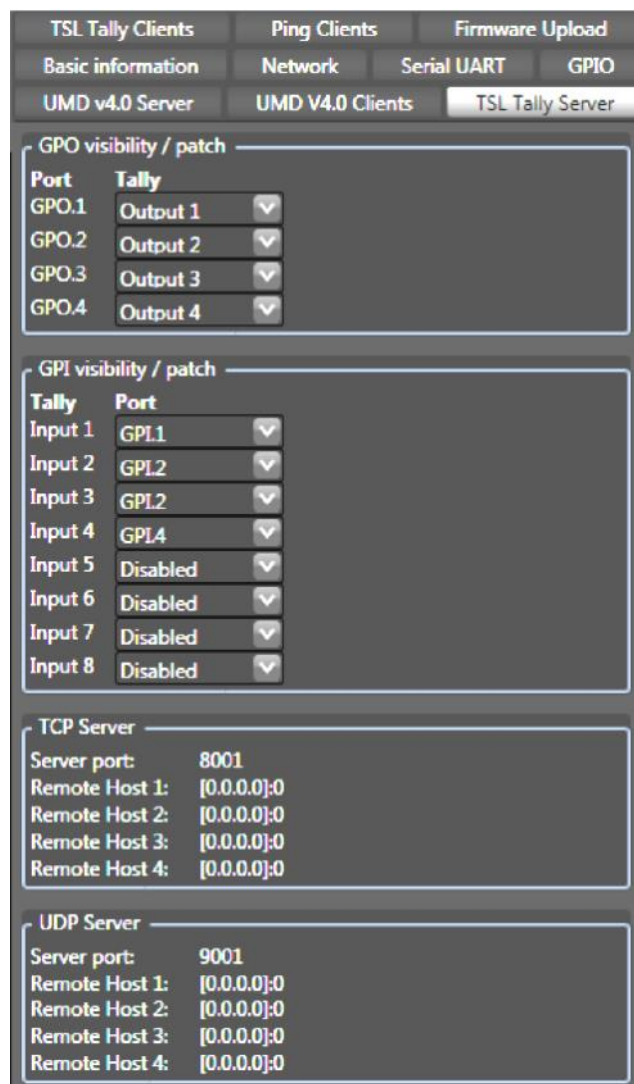

Web User Interface

To give users access to single BarnOne frames in a bigger system without having to install BarnStudio on their PC, or for users who do not run Windows, you can manage all functions available in BarnStudio by a web server running on each BarnOne frame.

The work station which needs to connect to a BarnOne frame has to be configured to run in the same network as the BarnOne frame, and you need to know the IP address of the frame to connect.

With a **Username** and **Password** you can enter the frame.

- Default User: *admin*
- Default Password: (no password)

The screenshot displays the web interface for a BarnOne frame. At the top, a browser window shows the URL 192.168.97.182. The interface includes a navigation menu with tabs for Basic information, Network, Inputs, Outputs, SFPS, Firmware Upgrade, Firmware Upload, and Diagnostics. A login section on the left contains fields for Username (admin) and Password, with a Login button. Below this, the 'Basic information' tab is active, showing details for Model: BTF1-07-16, SerialNumber: ser12735, and NetworkID. It also includes fields for sysName (BTF1-07), syLocation (Desk lower), and sysContact, each with a descriptive label and a Submit changes button. A 'Current network status' section shows IP Config and Route information. The 'Current network configuration file' section is divided into IPv4 and IPv6 operation modes, with radio buttons for DHCP/BOOTP, Disabled, LinkLocal, and Static. Below this are fields for IP addresses, Gateway, DNS servers, and DNS searches for both IPv4 and IPv6. The interface concludes with Submit changes and Refresh page buttons.

The Web UI offers the same functionality as BarnStudio.

This chapter only describes the differences between BarnStudio and the Web UI.

Submit Changes

There is no Take List to confirm the changes. Instead you can find 3 buttons at the bottom of each page:

- Submit changes
- Refresh page
- Cancel

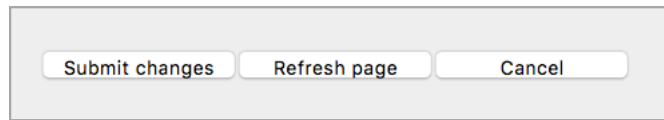

Input/Output Ports

Selecting the Input or Output tab will show an overview of the ports. You can monitor the signal analyzer etc.

Port name	Label	Equalizer	Signal analyzer
SFP #1:	Input port 1	Enabled:	Prescan: Result: Errors:
SFP #2:	Input port 2	Enabled:	Prescan: Result: Errors:
SFP #3:	Input port 3		
SFP #4:	Input port 4		
SFP #5:	Input port 5		
SFP #6:	Input port 6		
SFP #7:	Input port 7		
SFP #8:	Input port 8		
SFP #9:	Input port 9		
SFP #10:	Input port 10		
SFP #11:	Input port 11		
SFP #12:	Input port 12		
SFP #13:	Input port 13		
SFP #14:	Input port 14		
SFP #15:	Input port 15		
SFP #16:	Input port 16		
BNC #17:	Input port 17	Direction: Output 3G ext. reach Coarse amplitude: 800mV p-p	Enabled: Prescan: Result: Errors:
BNC #18:	Input port 18	Direction: Output 3G ext. reach Coarse amplitude: 800mV p-p	Enabled: Prescan: Result: Errors:
BNC #19:	Input port 19	Direction: Output 3G ext. reach Coarse amplitude: 800mV p-p	Enabled: Prescan: Result: Errors:
BNC #20:	Input port 20	Direction: Output 3G ext. reach Coarse amplitude: 800mV p-p	Enabled: Prescan: Result: Errors:
BNC #21:	Input port 21	Direction: Input 3G ext. reach Coarse amplitude: 800mV p-p	Enabled: Prescan: Result: Errors:
BNC #22:	Input port 22	Direction: Input 3G ext. reach Coarse amplitude: 800mV p-p	Enabled: Prescan: Unknown Result: Unknown HD Errors: NOSIGNAL
BNC #23:	Input port 24	Direction: Input 3G ext. reach Coarse amplitude: 800mV p-p	Enabled: Prescan: Unknown Result: Unknown HD Errors: NOSIGNAL
BNC #24:	Input port 25	Direction: Input 3G ext. reach Coarse amplitude: 800mV p-p	Enabled: Prescan: Unknown Result: Unknown HD Errors: NOSIGNAL
BNC #25:	Input port 26	Direction: Input 3G ext. reach Coarse amplitude: 800mV p-p	Enabled: Prescan: Unknown Result: Unknown HD Errors: NOSIGNAL
BNC #26:	Input port 27	Direction: Input 3G ext. reach Coarse amplitude: 800mV p-p	Enabled: Prescan: Unknown Result: Unknown HD Errors: NOSIGNAL
BNC #27:	Input port 28	Direction: Input 3G ext. reach Coarse amplitude: 800mV p-p	Enabled: Prescan: Unknown Result: Unknown HD Errors: NOSIGNAL
BNC #28:	Input port 29	Direction: Input 3G ext. reach Coarse amplitude: 800mV p-p	Enabled: Prescan: Unknown Result: Unknown HD Errors: NOSIGNAL
BNC #29:	Input port 30	Direction: Input 3G ext. reach Coarse amplitude: 800mV p-p	Enabled: Prescan: Unknown Result: Unknown HD Errors: NOSIGNAL
BNC #30:	Input port 31	Direction: Input 3G ext. reach Coarse amplitude: 800mV p-p	Enabled: Prescan: Unknown Result: Unknown HD Errors: NOSIGNAL

To perform changes in the settings of the port, select the link of the port number which will lead you to an extra page.



Basic information | Network | **Inputs** | Outputs | SFPS | Firmware Upgrade | Firmware Upload | Diagnostics

[Prev .. Port SFP #3: .. Next](#)

Port name	Label	Equalizer	Signal analyzer
SFP #3:	<input type="text" value="Chance port label"/>		Enabled: <input checked="" type="checkbox"/> Prescan: Unknown Result: Unknown HD Errors: NOSIGNAL

Select your changes, scroll down to the bottom of the page and confirm the changes. By selecting «Prev.» or «Next» you can navigate directly to the previous or next port without going back to the Input/Output page.

Routing

Barnfind's Web UI does not have the «Matrix» tab which you are used to from Barnstudio. To change a cross point select the link of the port number in the Outputs Port settings by selecting the input from a drop down list and confirm the change.

The screenshot shows the 'Outputs' configuration page for SFP #3. The 'Redundancy switch' section is highlighted in green. It includes settings for Operation mode (Enabled), Status (Normal), Timeout (1000 ms), Switchback to main (Disabled), and Switchback timeout (30000 ms). Below these is a table of active inputs and sensitive settings.

Active inputs	Sensitive to		
	LOS	Analyzer lock	Analyzer errors
SFP #1 - Input port 1	(not used)	<input type="checkbox"/>	<input type="checkbox"/>
SFP #2 - Input port 2	(not used)	<input type="checkbox"/>	<input type="checkbox"/>
SFP #3 - Input port 3	(not used)	<input type="checkbox"/>	<input type="checkbox"/>
SFP #4 - Input port 4	(not used)	<input type="checkbox"/>	<input type="checkbox"/>
SFP #5 - Input port 5	(not used)	<input type="checkbox"/>	<input type="checkbox"/>
SFP #6 - Input port 6	(not used)	<input type="checkbox"/>	<input type="checkbox"/>
SFP #7 - Input port 7	(not used)	<input type="checkbox"/>	<input type="checkbox"/>
SFP #8 - Input port 8	(not used)	<input type="checkbox"/>	<input type="checkbox"/>
SFP #9 - Input port 9	(not used)	<input type="checkbox"/>	<input type="checkbox"/>
SFP #10 - Input port 10	(not used)	<input type="checkbox"/>	<input type="checkbox"/>
SFP #11 - Input port 11	(not used)	<input type="checkbox"/>	<input type="checkbox"/>
SFP #12 - Input port 12	(not used)	<input type="checkbox"/>	<input type="checkbox"/>
SFP #13 - Input port 13	(not used)	<input type="checkbox"/>	<input type="checkbox"/>
SFP #14 - Input port 14	(not used)	<input type="checkbox"/>	<input type="checkbox"/>
SFP #15 - Input port 15	(not used)	<input type="checkbox"/>	<input type="checkbox"/>
SFP #16 - Input port 16	(not used)	<input type="checkbox"/>	<input type="checkbox"/>
BNC #17 - Input port 17	(not used)	<input type="checkbox"/>	<input type="checkbox"/>
BNC #18 - Input port 18	(not used)	<input type="checkbox"/>	<input type="checkbox"/>
BNC #19 - Input port 19	(not used)	<input type="checkbox"/>	<input type="checkbox"/>
BNC #20 - Input port 20	(not used)	<input type="checkbox"/>	<input type="checkbox"/>
BNC #21 - Input port 21	(not used)	<input type="checkbox"/>	<input type="checkbox"/>
BNC #22 - Input port 22	(not used)	<input type="checkbox"/>	<input type="checkbox"/>
BNC #23 - Input port 23	(not used)	<input type="checkbox"/>	<input type="checkbox"/>
BNC #24 - Input port 24	(not used)	<input type="checkbox"/>	<input type="checkbox"/>
BNC #25 - Input port 25	(not used)	<input type="checkbox"/>	<input type="checkbox"/>

A callout box titled 'SFP #3:' shows a list of signal sources from SFP #1 to BNC #24. The 'No source' option is selected with a checkmark.

Redundancy Change Over

As well to be found under the Output port settings is the Redundancy Change Over, which is described in detail under BarnStudio.

This screenshot shows the 'Redundancy switch' configuration for SFP #3. The 'Operation mode' is set to 'Disabled'. The 'Status' dropdown menu is open, showing options: Disabled (selected), Enabled, and Temporary disabled. The 'Timeout (ms)' is 1000, 'Switchback to main' is Disabled, and 'Switchback timeout (ms)' is 30000.

Active inputs	Sensitive to		
	LOS	Analyzer lock	Analyzer errors
SFP #1 - Input port 1	(not used)	<input type="checkbox"/>	<input type="checkbox"/>
SFP #2 - Input port 2	(not used)	<input type="checkbox"/>	<input type="checkbox"/>
SFP #3 - Input port 3	(not used)	<input type="checkbox"/>	<input type="checkbox"/>
SFP #4 - Input port 4	(not used)	<input type="checkbox"/>	<input type="checkbox"/>
SFP #5 - Input port 5	(not used)	<input type="checkbox"/>	<input type="checkbox"/>
SFP #6 - Input port 6	(not used)	<input type="checkbox"/>	<input type="checkbox"/>
SFP #7 - Input port 7	(not used)	<input type="checkbox"/>	<input type="checkbox"/>
SFP #8 - Input port 8	(not used)	<input type="checkbox"/>	<input type="checkbox"/>
SFP #9 - Input port 9	(not used)	<input type="checkbox"/>	<input type="checkbox"/>

3rd party control for BarnOne

Telnet

External control of BarnOne frames and BarnMini-05 can be realised by Telnet protocol. A detailed description can be found in the download section of the Barnfind website.

<https://media.barnfind.no/BTF1%20Telnet%20Documentation%20revision%201.0.pdf>

SNMP

BarnStudio and some few 3rd party integrators can connect to BTF1-XX frames using the SNMP protocol. This is a binary protocol that uses external meta information (MIB) to map parameters to human readable names. This meta information (MIB) can be downloaded from the download section on our website (together with documentation and command line examples if using the net-snmp software, a command line based SNMP tool). SNMP gives you full access to all parameters. For read-only access the community name “public” can be used. For read/write access the community name “private” must be used.

<https://media.barnfind.no/20171201%20Barnfind%20MIB.zip>

SW-P-08

SW-P-08 is an old versatile protocol that gives you access to only configure and view the status of the matrix, and also gives direct feedback about matrix changes. This protocol is very commonly used by panels and 3rd party control software due to its relative simple design and widely spread device support range. The specification must be retrieved from Snell Advanced Media. The BTF1-XX frames listen for SW-P-08 connections on TCP port 1096. The support was added in firmware version 0.1.7.

BlackMagic VideoHub

BlackMagic VideoHub is an open protocol used by BlackMagic products documented in the “BlackMagic Videohub SDK”. The protocol is text based with new lines made by using the \n character only. BTF1-XX implementation allows 3rd party to control the matrix component only, and makes it possible to control the router using “BlackMagic Smart Control” panel and “BlackMagic VideoHub” software. The BTF1-XX frames listens for connection on TCP port 9990. The support was added in firmware version 0.2.4.

Ember+

The latest implementation of 3rd party control protocols is Ember+, enabling full control functionality and seamless integration into existing environment with SFP readout, redundancy change over etc. for control systems mentioned below.

Other

BTF1-XX can control and be controlled by many software/hardware panels. Displayed below are some few manufacturers.



openGear protocol

The openGear protocol (also known as OGP) is an open protocol developed by Ross (who must be contacted if the specifications are needed). The support for OGP was added in firmware version 0.1.7. The BTF1-XX frames does not broadcast its openGear connection details, so it has to be added manually in dashboard using the follow dialog.

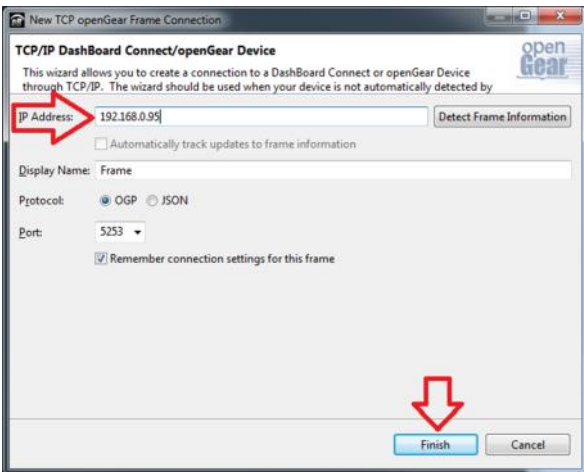
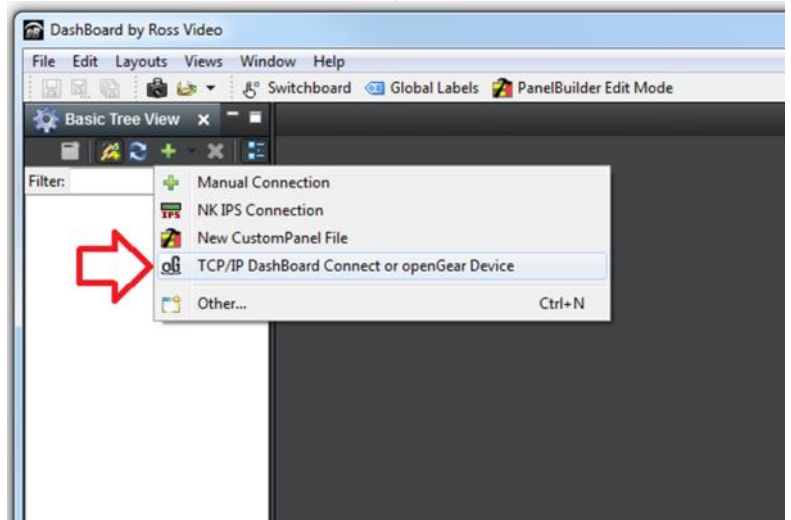
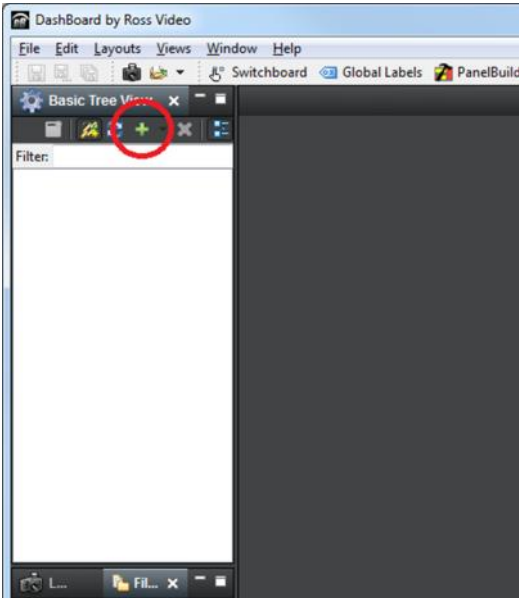

openGear gives you access to all parameters except viewing the network status and changing the network configuration. The protocol is in general more responsive than SNMP, since it feeds back changes on the already existing same TCP/IP connection.

Download free version of DashBoard:

<http://www.rossvideo.com/control-systems/dashboard/products/dashboard.html>

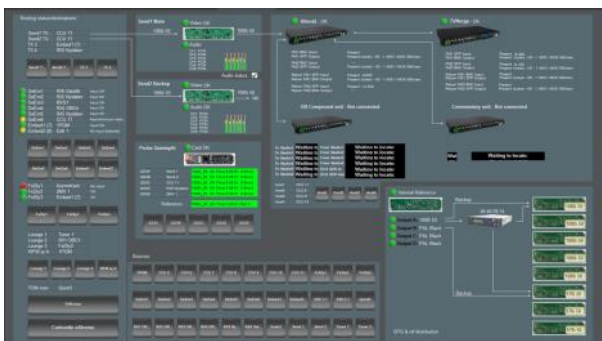

Example of panel using Barnfind frames.



Applications

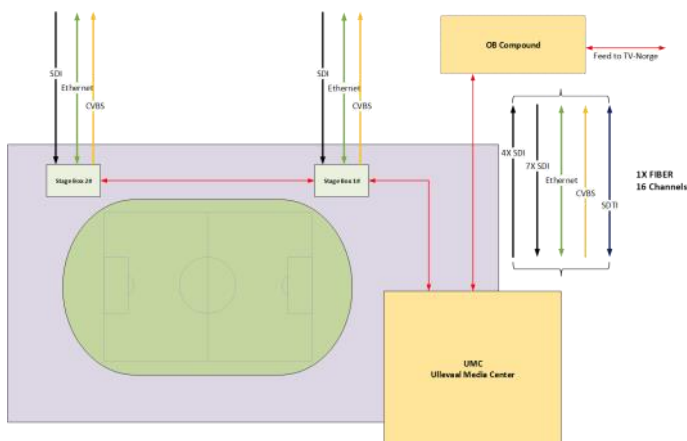
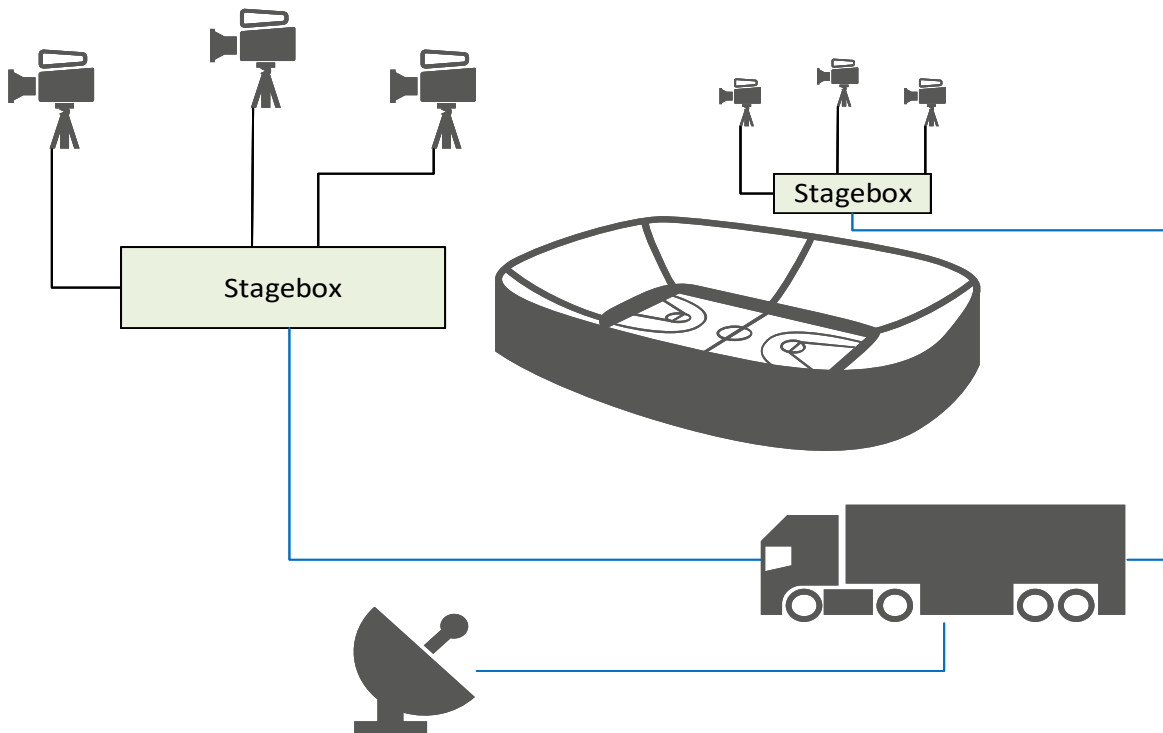
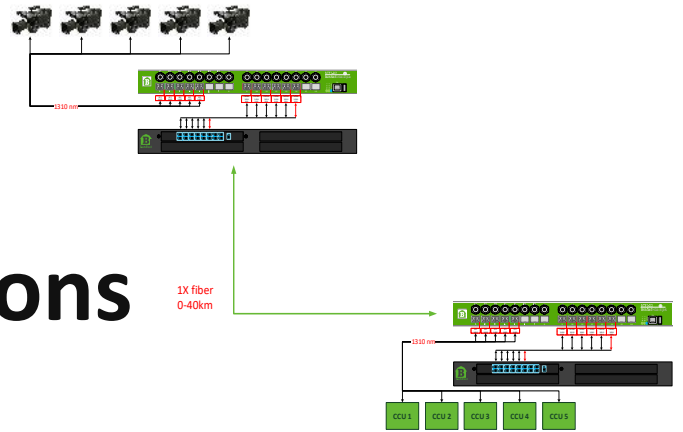

Colour conversion

1310nm, and sometimes 1550nm are common used wavelengths on equipment with fixed (not SFP) transmitter and receiver. You will find it on RS-protocols to fiber converters, Intercom systems, HDMI extenders, optical routers and many more. The example below describe how we can convert 1310, 1550 or any other wavelengths into CWDM.

CWDM SFPs

Frame equipped with CWDM SFPs. The incoming optical signal is 1310 nm on all channels. The signals are routed to an output with colored light, CWDM

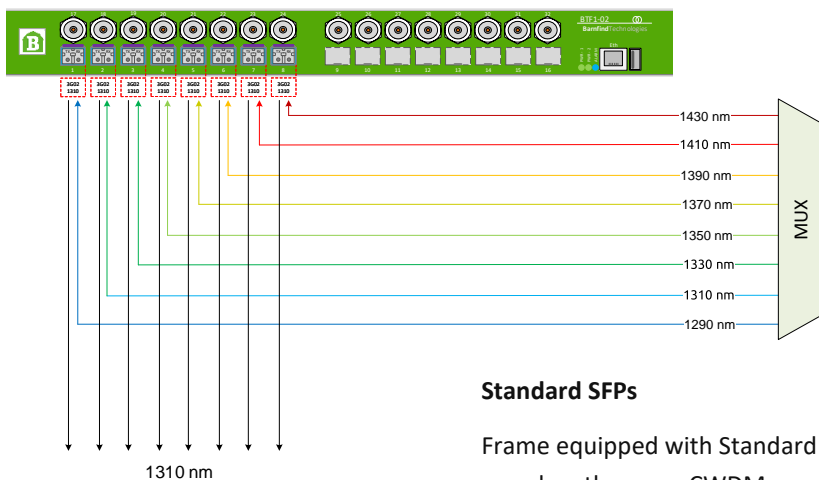
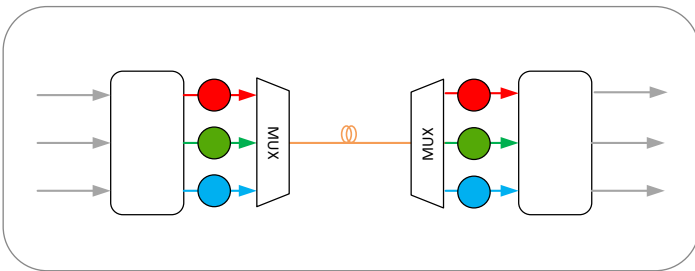
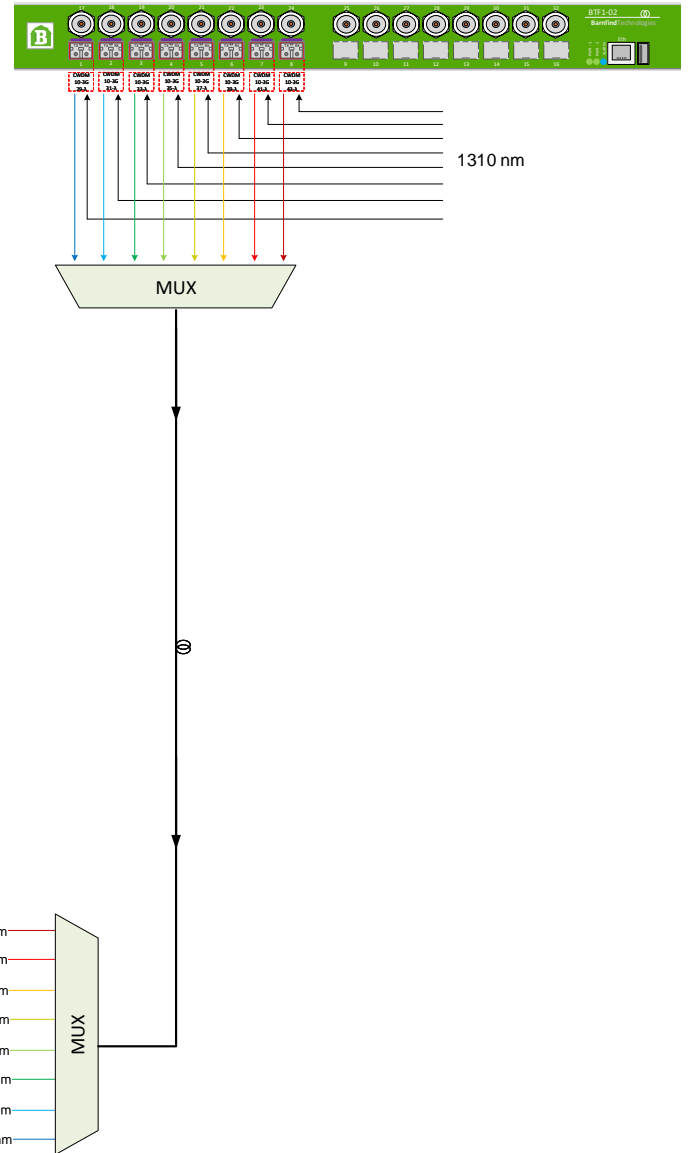

Standard SFPs

Frame equipped with Standard SFPs. Note!, the RX (receiver) can read all wavelengths, even CWDM wavelengths. The output is 1310 nm.

Signal distribution/contribution

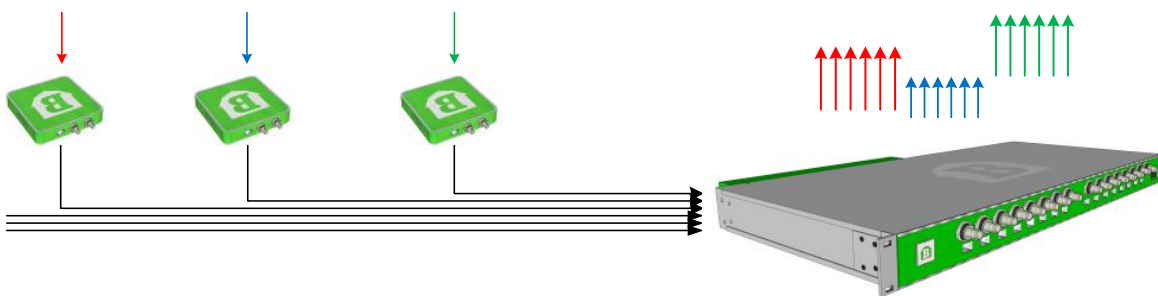
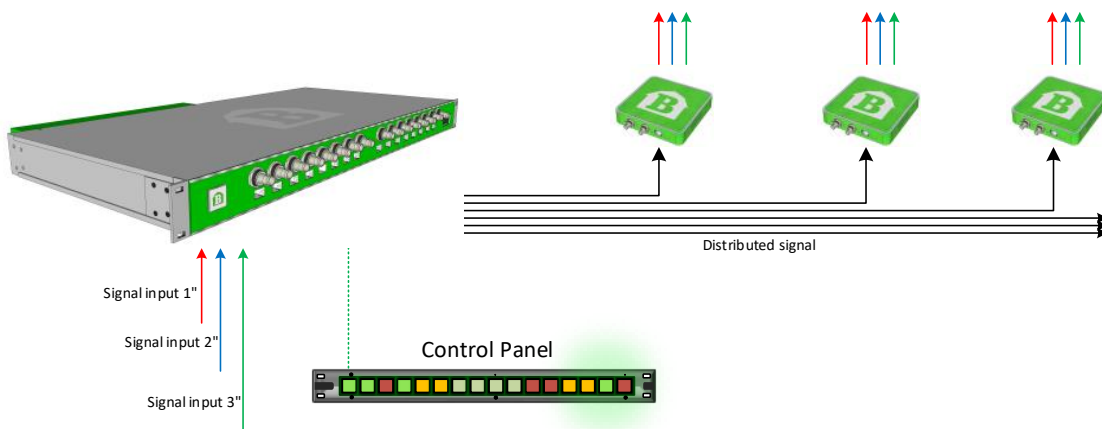
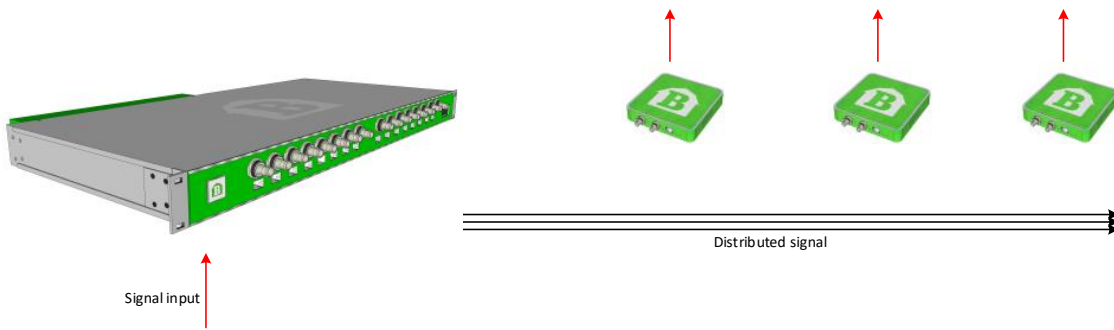

Camera to CCU I

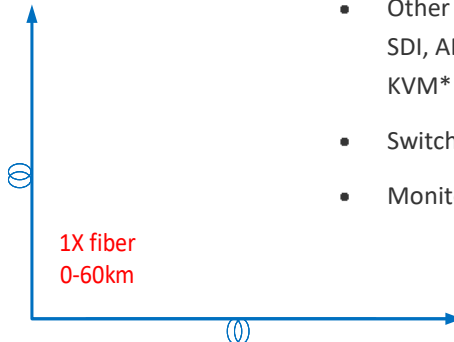
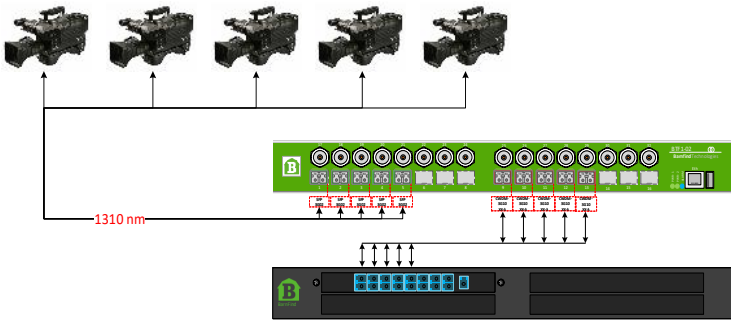

Figures shows the bidirectional signal transport between a camera from any supplier to a camera control unit (CCU). Up to 18 cameras/CCU can be multiplexed into 1 fiber for transport over long distances. The internal matrix in BarnOne frame allows the user to switch any camera to any CCU.

- Up to 18 CAM/CCU in 1 single mode fiber.
- Includes transmission of video, audio, tally, inter-com and RCP.
- Other signal can be multiplexed into same fiber. SDI, AES, ASI, HDMI, Ethernet, CVBS, SDTI, MADI, KVM*
- Switching functionalities between CAM and CCU.
- Monitoring of the signal flow.

BOM list	
Product Name	Quantity
BT-CWDM-10-3Gxx	10
BT-CWDM-16	2
BT-HOUS	2
BT-LX-SM-3G02	10
BTF1-02	2

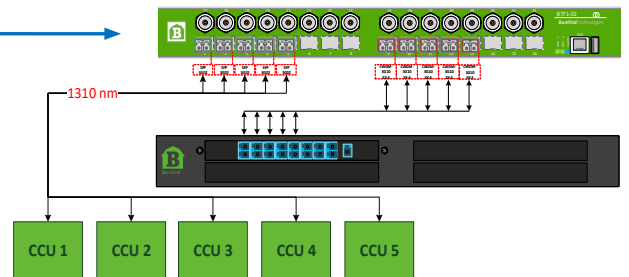

*Other signal can be multiplexed into same fiber. SDI, AES, ASI, HDMI, Ethernet, CVBS, SDTI, MADI, KVM

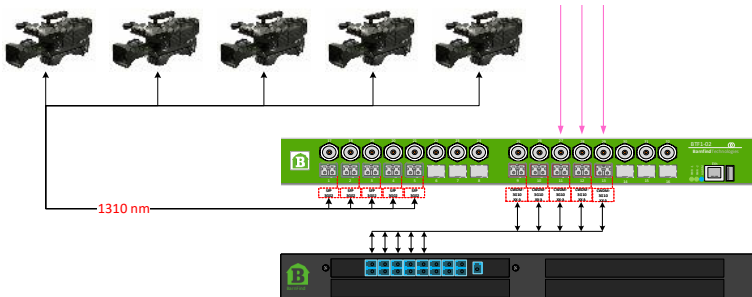

Stage box

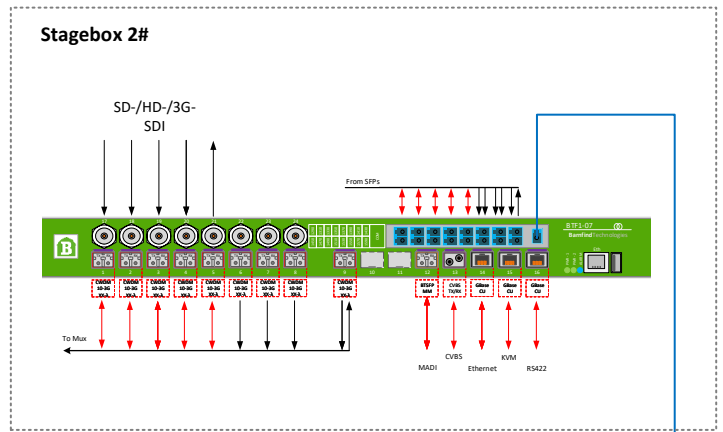
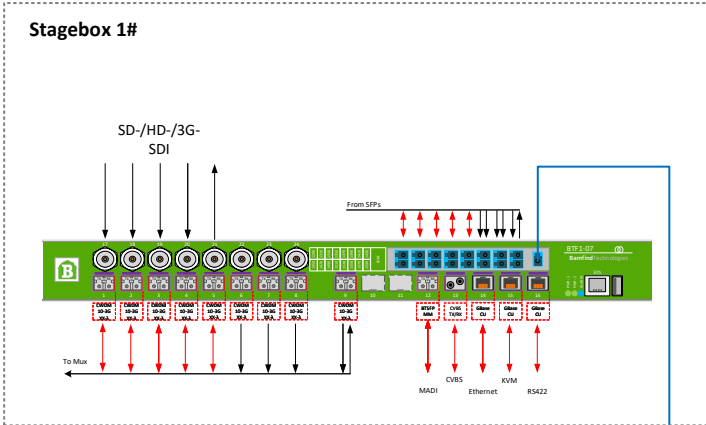
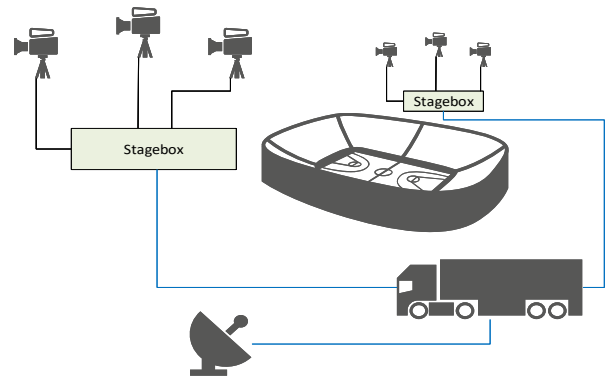

BOM list	
Product Name	Quantity
BT-CWDM-10-3G	36
BT-CWDM-MUX-16-LGX	2
BT-HOUS-LGX-1RU	1
BTF1-02	2
BTF1-07-16	2
BTSFP-GBaser-CU	12
BTSFP-MM-1G	4
EB30HDRT-AM	4

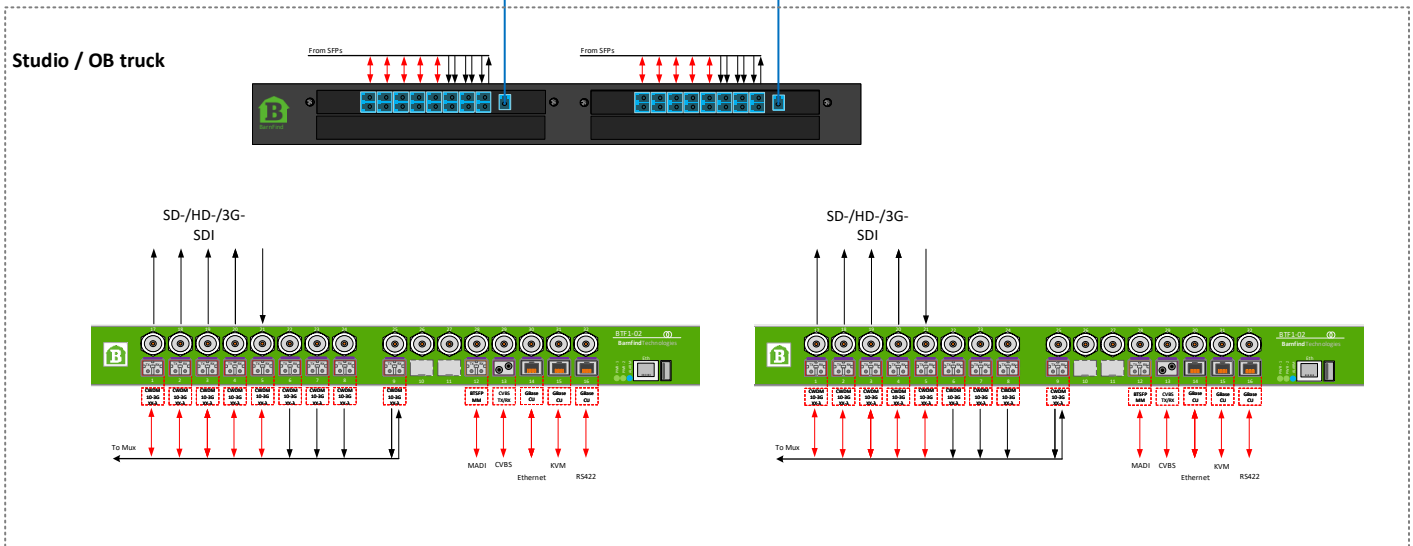

Ethernet transmission I

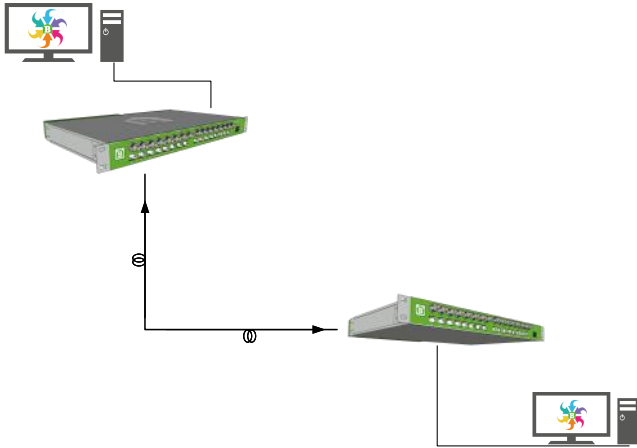

To establish an Ethernet connection over fiber by using Barnfind products, configure your setup as picture below describes.

Shown examples are using a point to point connection with 2x fiber cables. Alternative setup could be WDM, CWDM or DWDM technology.

Regardless of point to point or multiplexed connection, the user must ensure the RX is connected to TX and vice versa.

 **Use an Ethernet switch in both ends to ensure same link speed.**

Example 1

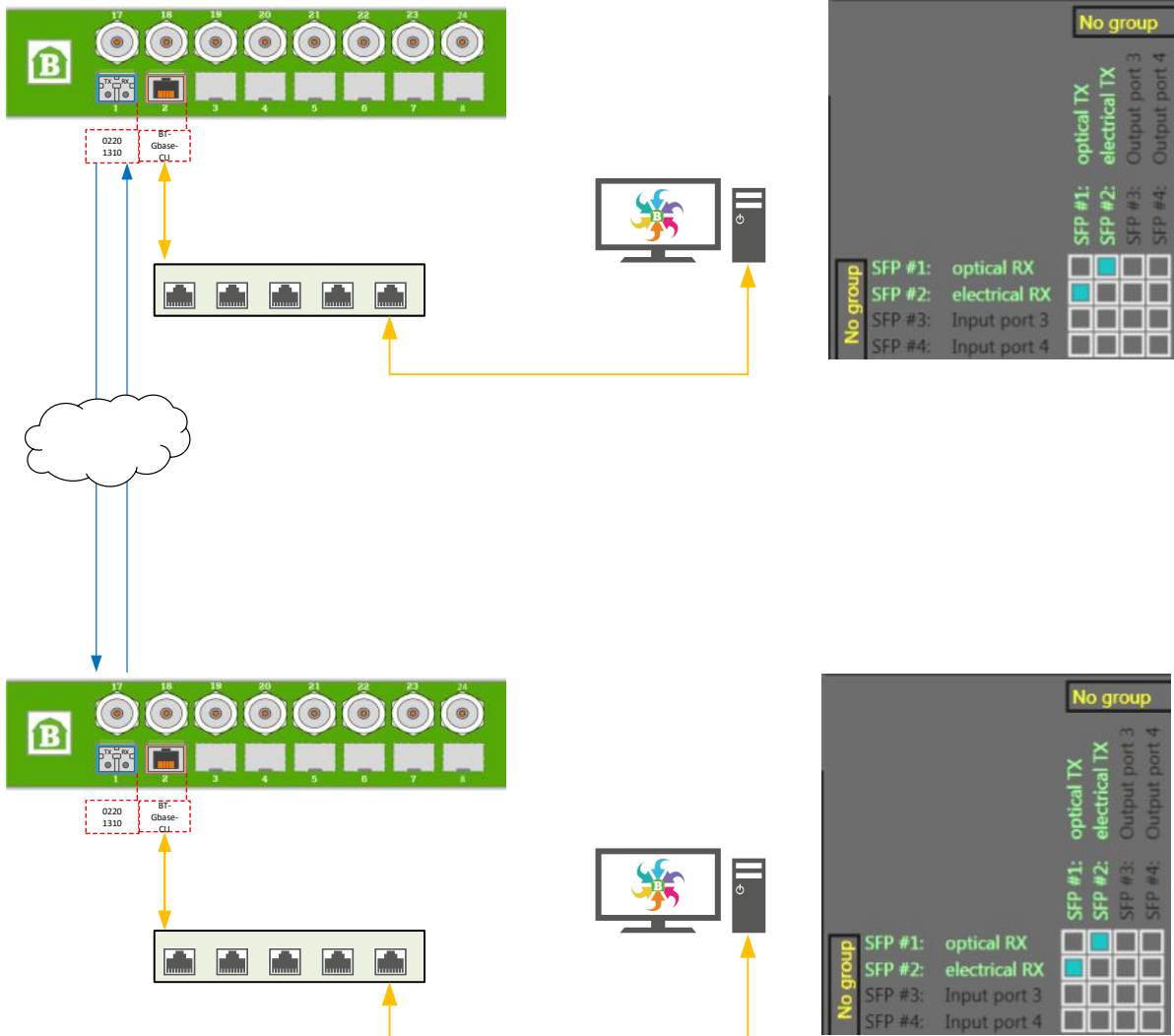

Example 2

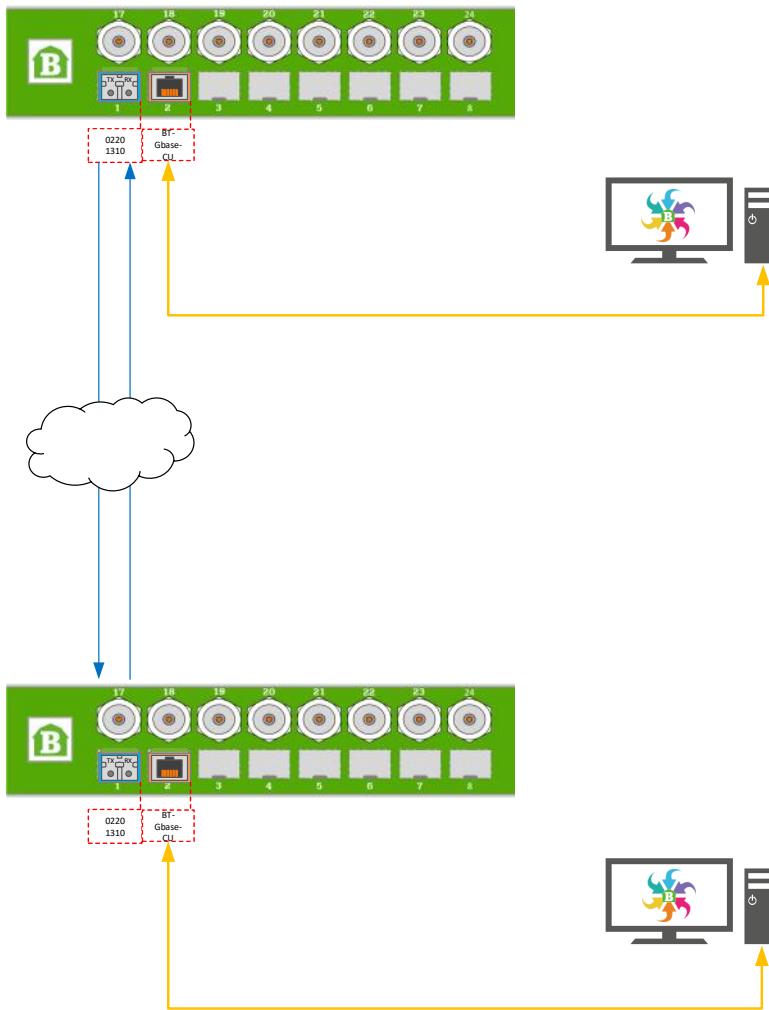

Basic information Network Matrix Inputs Outputs SFPs Firmware Upgrade Firmware Upload Diagnostics Auth database

Name	Value
Link duplex	Half Duplex
Link MDI	MDI
Link speed	100Mbps
Link status	Link up
Operating mode	SGMII(default)
User selectable link speed	100Mbps Half Duplex
	Auto(default)
	1Gbps Full Duplex
	1Gbps Half Duplex
	100Mbps Full Duplex
	100Mbps Half Duplex
	10Mbps Full Duplex
	10Mbps Half Duplex

The link speed must be the same in both ends. You can enforce this using BarnStudio.

With this setup, you will not need the network switch in between.

KVM transmission

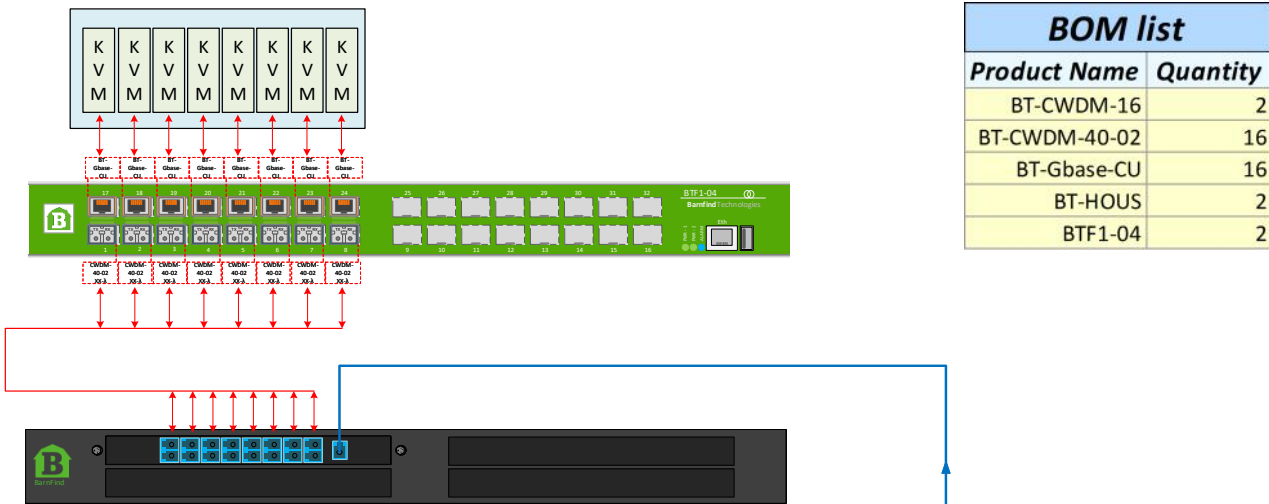

BOM list	
Product Name	Quantity
BT-CWDM-16	2
BT-CWDM-40-02	16
BT-Gbase-CU	16
BT-HOUS	2
BTF1-04	2

KVM with optical connection

The example shows a KVM systems equipped with electric connection on RJ45. Some systems are equipped with optical ports and use 1310/1550 optical signals for communication.

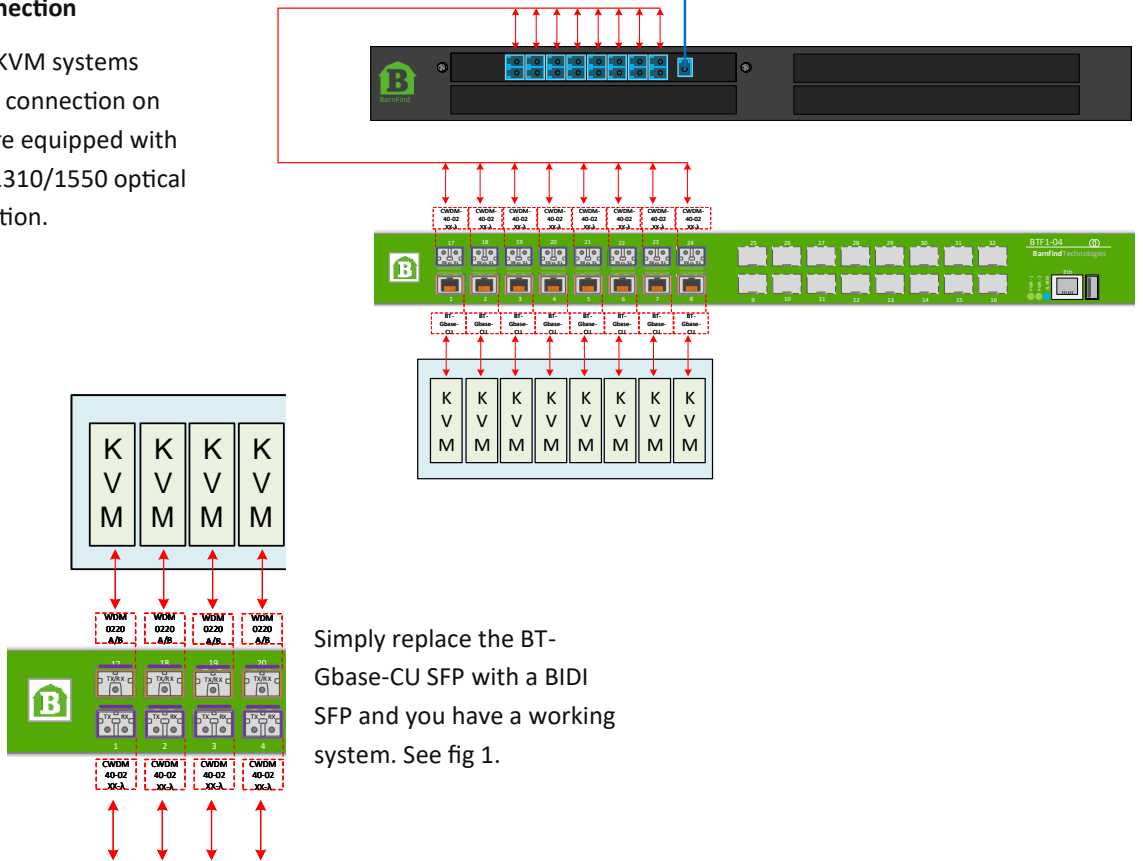

Simply replace the BT-Gbase-CU SFP with a BIDI SFP and you have a working system. See fig 1.

Fig. 1

Ethernet transmission II

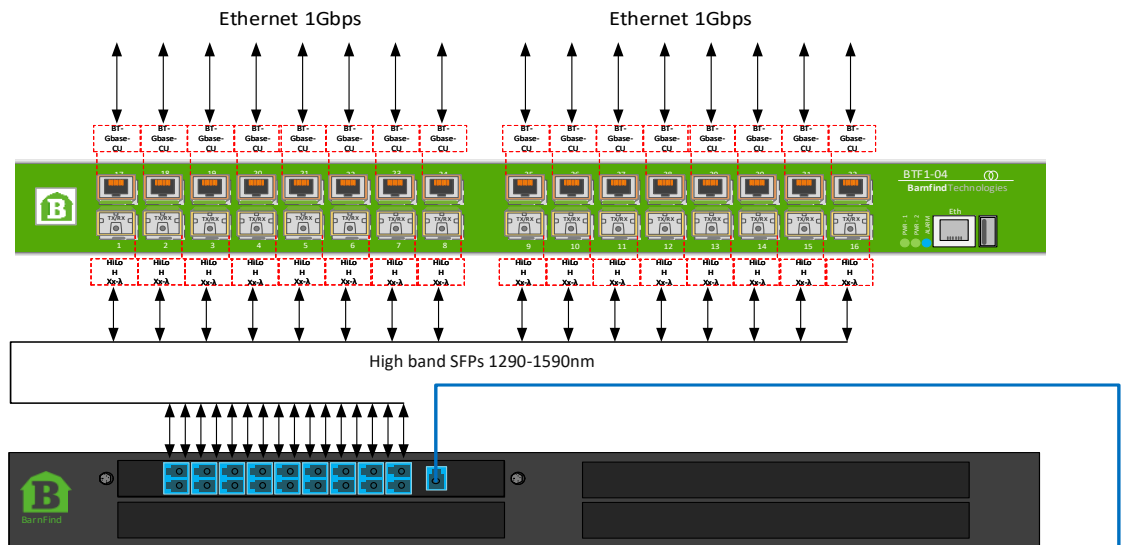

- 16X 1Gbps Ethernet
- Only 1 Single Mode fiber when using HiLo technology
- Only 2RU each side
- Optional redundancy line
- Up to 20km distance

BOM list	
<i>Product Name</i>	<i>Quantity</i>
BT-CWDM-16	2
BT-Gbase-CU	32
BT-HOUS	2
BTF1-04	2
BT-3G-xx-H/L	32

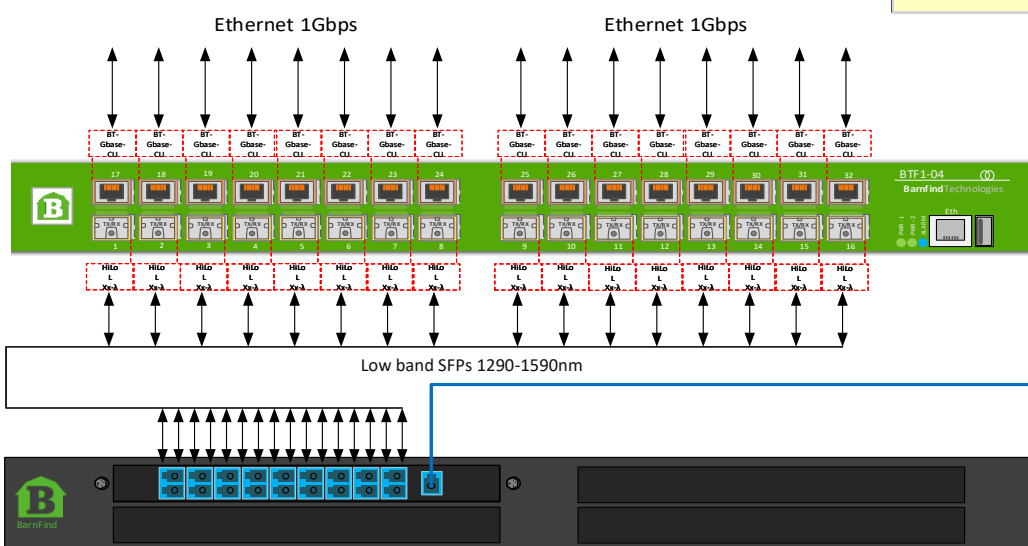

Camera to CCU II

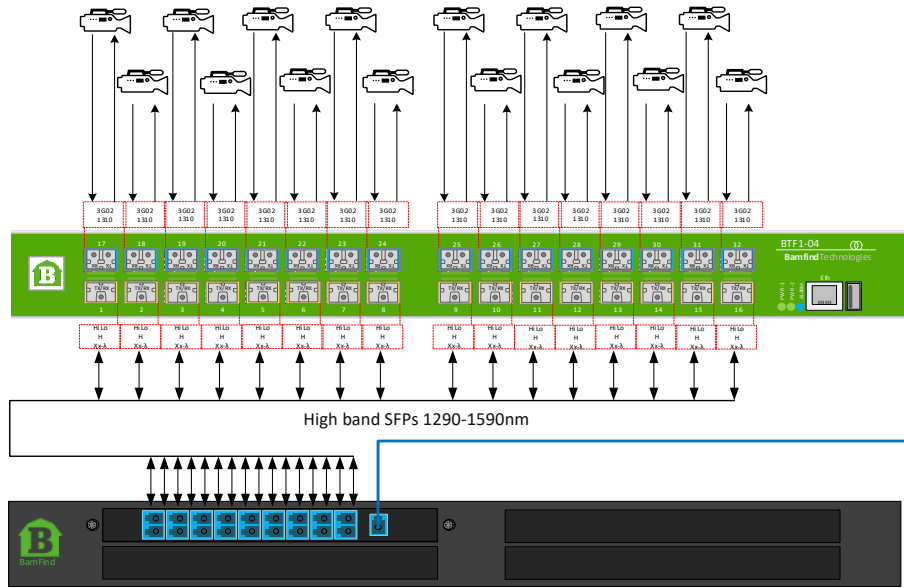

- 16X CAM-CCU
- Only 1 Single Mode fiber when using HiLo technology
- Only 2RU each side
- Optional redundancy line
- Up to 20km distance

BOM list	
Product Name	Quantity
BT-CWDM-16	2
BTSFP-LX-SM-3G02	32
BT-HOUS	2
BTF1-04	2
BT-3G-xx-H/L	32

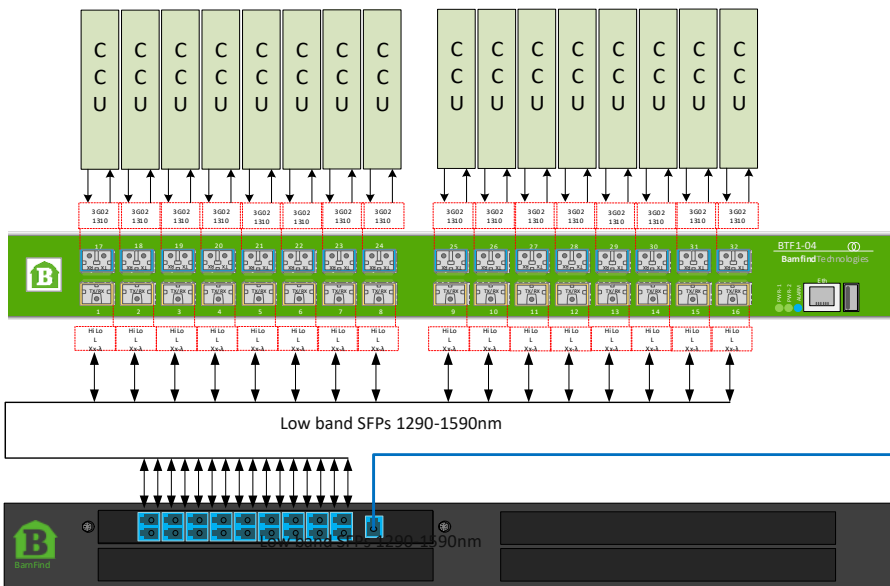



TroubleShooting



CAM-CCU - details

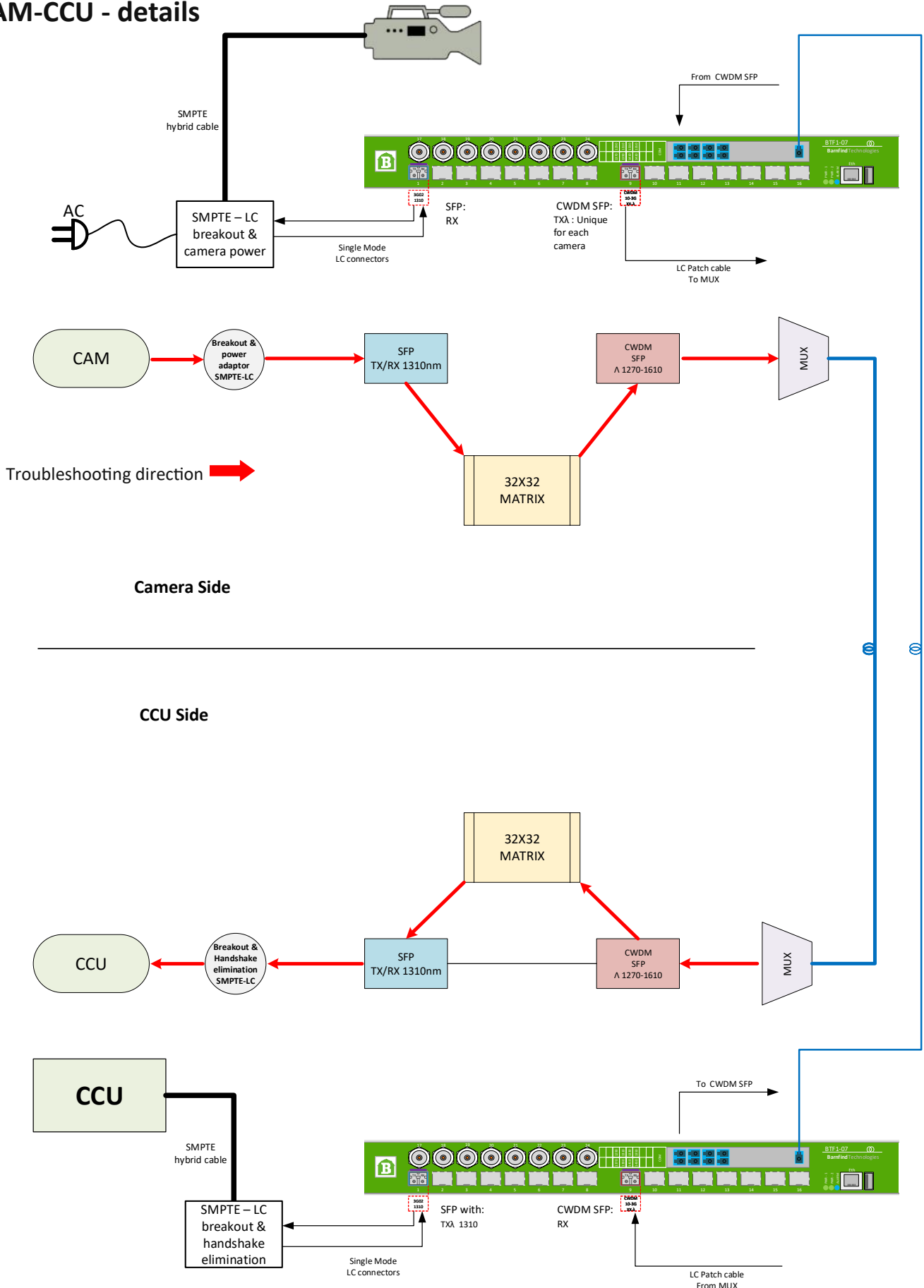

CAM-CCU - troubleshooting workflow

This workflow troubleshooting refer to the previous page with a single CAM– CCU transmission. Note, you can set up the system to handle up to 18 cameras and 18 CCU (see example of 16 camera link on page 59). A more detailed checklist will follow to ensure a smooth installation.



Camera from any of the most commonly used professional camera manufacturers e.g. Ikegami, Sony, Hitachi, Panasonic etc.
Camera and CCU have to be in «Single Fiber Mode», you will find this option in the camera system menu or you can utilise a SMPTE hybrid elimination device (SHED/SHACK/HUT etc.) depending on the type of camera.

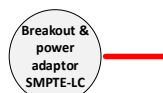

You will need a device powering the camera through a SMPTE hybrid cable and extracting the fibers from the SMPTE hybrid cable to LC connectors, which you connect to the SFP in BarnOne.
 Alternatively, you can power the camera locally and connect it with a SMPTE—LC adaptor cable to BarnOne. a breakout panel with SMPTE connector to LC connector.

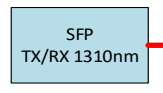

The purpose of this SFP is to receive the signals from camera (1310nm) and to transmit the signals from CCU (1310nm)

Some installation advices:

- Use BarnStudio to verify if you have the correct optical power on the RX connector. The LC connectors at the breakout cable is 'normally' not labeled, and it is impossible to visually see the difference of TX and RX. **DO NOT TRY TO LOOK INTO THE FIBER CONNECTOR!**



Name	Value
RX LOS	<input checked="" type="checkbox"/>
RX Power dBm	-40 dBm
RX Power mW	0,0001 mW
Temperature	46,5 C
TX Bias	10,464 mA
TX Disable	<input type="checkbox"/>
TX Fault	<input type="checkbox"/>
TX Power	0,7255 mW
TX Power dBm	-1,39 dBm
Vcc	3,1216 V

The value '-40 dBm' will appear if the optical signal is not present or if the optical signal is too high.

- Try to swap the LC connectors
- Insert an attenuator

BarnStudio will take about 5 seconds to update the value.

A perfect signal is between -5dBm to -20dBm.

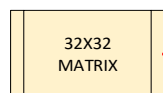

The crosspoint switch (Matrix) must be set up correctly to ensure a link between input (camera) and output (optical signal with CWDM wavelength). From example on previous page, the configuration is:

Input port 1 -> Output port 9

Input port 9 -> Output port 1

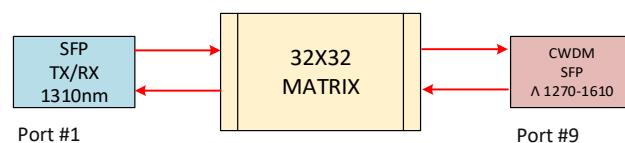

	SFP #1: Output port 1	SFP #2: Output port 2	SFP #3: Output port 3	SFP #4: Output port 4	SFP #5: Output port 5	SFP #6: Output port 6	SFP #7: Output port 7	SFP #8: Output port 8	SFP #9: Output port 9	SFP #10: Output port 10	SFP #11: Output port 11	SFP #12: Output port 12
SFP #1: Input port 1												
SFP #2: Input port 2												
SFP #3: Input port 3												
SFP #4: Input port 4												
SFP #5: Input port 5												
SFP #6: Input port 6												
SFP #7: Input port 7												
SFP #8: Input port 8												
SFP #9: Input port 9												
SFP #10: Input port 10												
SFP #11: Input port 11												
SFP #12: Input port 12												

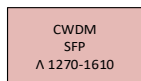

The purpose of this SFP is to transmit the camera signal to the multiplexer.

Note! You must use a unique wavelength for each signal. There are 18 different selections of wavelegths in the CWDM range.

It is also important to keep in mind that a CWDM SFP transmit on one specific wavelength, but can receive any wavelength in the CWDM range.

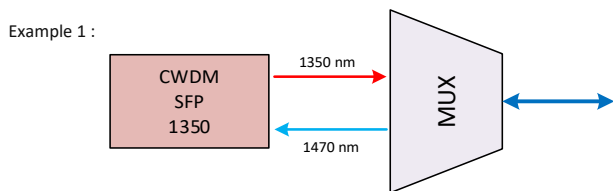

Example 2, with multiple signals:

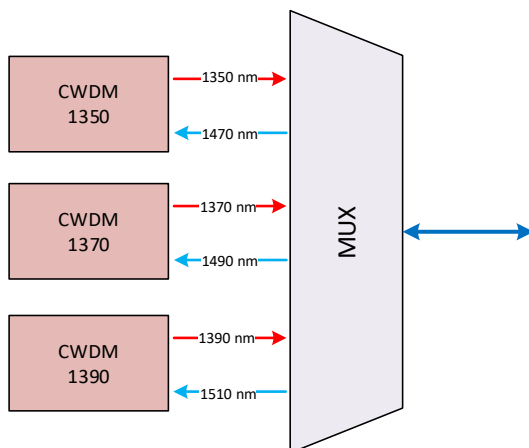

Use BarnStudio to verify if you have the correct optical power on the RX connector.



Name	Value
RX LOS	<input checked="" type="checkbox"/>
RX Power dBm	-40 dBm
RX Power mW	0,0001 mW
Temperature	46.5 C
TX Bias	10,464 mA
TX Disable	<input type="checkbox"/>
TX Fault	<input type="checkbox"/>
TX Power	0,7255 mW
TX Power dBm	-1,39 dBm
Vcc	3,1216 V

The value '-40 dBm' will appear if the optical signal is not present or if the optical signal is too high.

- Add in an attenuator

BarnStudio will take about 5 seconds to update the value.

A perfect signal is between -5dBm to -15dBm.



This is the final step on the transmitter side. All wavelengths from CWDM SFPs are collected in the optical multiplexer and can be transmitted as one combined signal, in one fiber.

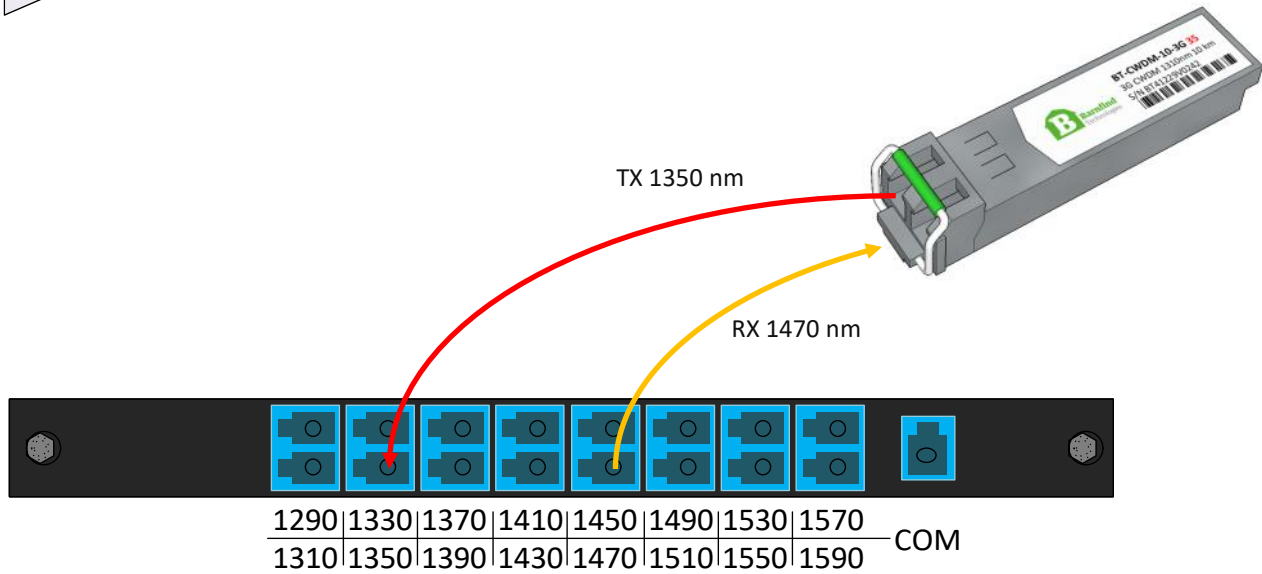

Attenuators

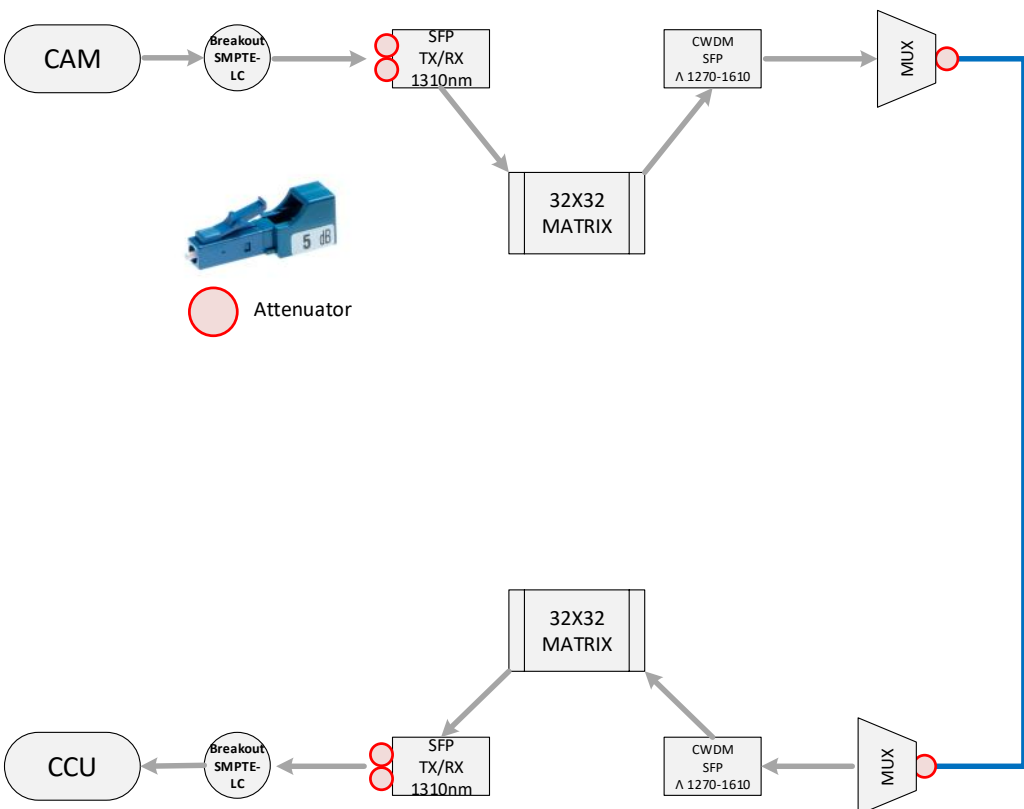

An optical receiver e.g. in camera, CCU or SFP will automatically shut down when the optical power is too high. In BarnStudio, this will be indicated as -40dBm.

To ensure a correct optical level, you must use attenuators. **Typically the optical level should be within the range:**

-5dBm to -20dBm

Name	Value
RX LOS	<input checked="" type="checkbox"/>
RX Power dBm	-6,05 dBm
RX Power mW	0,2482 mW
Temperature	43,25 C
TX Bias	8,64 mA
TX Disable	<input type="checkbox"/>
TX Fault	<input type="checkbox"/>
TX Power	0,5696 mW
TX Power dBm	-2,44 dBm
Vcc	3,1008 V



Troubleshooting

BTF1-XX frames and connection

Problem	Possible Cause	Suggested Correction
Frame does not appear in BarnStudio Device list	Network cable(s)	Change cable(s)
	Network switch broken/unplugged	Change Network switch (connect directly from computer to frame to verify)
	Wrong/no settings in [Multicast Search Scope] see page 36.	Change settings according to BarnGuide page 36
	Wrong/no matching IP network see page 40	Change settings according to BarnGuide page 40
	Frame is not powered up	Power up frame. At least one green LED in front should be illuminated.
Blue LED in front is flashing (Alarm)	A critical component, fan speed, temperature or PSU has reached a level outside 'normal' range	Use BarnStudio [Diagnostics] to read information about the error. Uncheck to turn off the LED indication. See page 47
Frame or SFP is overheating (Alarm)	Minor cooling airflow, hot or dusty environment	If fans are not running, open cassette to check connector
		make sure fan speed is running at +7000rpm
		Add filter if dusty environment/Clean filter
Missing functionalities	Frame has old firmware	Upgrade frame to latest firmware. See page 46
	BarnStudio is old version	Download latest BarnStudio http://www.barnfind.no/downloads

Input and output ports

Problem	Possible Cause	Suggested Correction
Can not receive signal (Optical)	Verify if the input is connected to the correct output(s)	Check and correct crosspoint in BarnStudio [Matrix]
	Optical signal in is too strong	BarnStudio will indicate -40dBm. Add attenuator. See page 63.
	Optical signal in is too weak/missing	Verify incoming signal with an optical power meter.
	Signal format is outside SFP range e.g 3G-SDI->1.25Gbps SFP	Replace SFP
	Wrong connection to SFP. Note, RX is rightside connector seen from front	Swap connectors (fiber connectors)
Can not transmit signal (Optical)	Verify if the output is connected to the correct input	Check and correct crosspoint in BarnStudio [Matrix]
	Signal format is outside SFP range e.g 3G-SDI->1.25Gbps SFP	Replace SFP
	TX turned off	Enable TX in BarnStudio [Output]. Default ON
	Reclocker Bypassed	Change reclocker status to AUTO (default)
Can not receive signal (BNC)	Verify if the input is connected to the correct output(s)	Check and correct crosspoint in BarnStudio [Matrix]
	The port (BNC) is configured as output	Change the direction in BarnStudio [Input or Output] see page 43, 44
	Signal format is outside range	Maximum datarate is 3.2Gbps
Can not transmit signal (BNC)	Verify if the output is connected to the correct input	Check and correct crosspoint in BarnStudio [Matrix]
	The port (BNC) is configured as input	Change the direction in BarnStudio [Input or Output] see page 43, 44
	Reclocker Bypassed	Change reclocker status to AUTO (default)

Questionnaire for fiber optical transmission

1 **System Name** (please give a name we can use for communication)

2 **How many locations?**

3 **Is the fiber cable in place/installed already?**

3.1 If YES, how many fiber strands are available between the locations?

3.2 If YES, what kind of fiber is installed, single mode or multimode?

3.3 If NO, how many fiber strands shall be installed?

4 **What is the distance between the single locations?**

5 **Is multiplexing an option to reduce the fiber count?**

6 **Do you wish optical redundancy?**

7 **Comments** (please feel free to give as much information as you would like to)

8 Signal list for each location, please list how many signals of each type

8.1 Loc A:

		<i>Please insert quantity</i>
8.1.1	SD-, HD-, 3G-SDI In:	
8.1.2	SD-, HD-, 3G-SDI Out:	
8.1.3	6G/12G SDI In:	
8.1.4	6G/12G SDI Out:	
8.1.5	HDMI In:	
8.1.6	HDMI Out:	
8.1.7	1Gbps Ethernet (specify electr./ opt., SM/MM):	
8.1.8	10Gbps Ethernet (specify electr./ opt., SM/MM):	
8.1.9	GPI:	
8.1.10	GPO:	
8.1.11	RS422/485 (specify)	
8.1.12	ASI/MADI/AES In electr.:	
8.1.13	ASI/MADI/AES In opt.:	
8.1.14	Analog Audio In:	
8.1.15	Analog Audio Out:	
8.1.16	Other opt. In (e.g. CAM-CCU/proprietary):	
8.1.17	Other opt. Out (e.g. CAM-CCU/proprietary):	
8.1.18	Comments:	

8.2 Loc B:

		<i>Please insert quantity</i>
8.2.1	SD-, HD-, 3G-SDI In:	
8.2.2	SD-, HD-, 3G-SDI Out:	
8.2.3	6G/12G SDI In:	
8.2.4	6G/12G SDI Out:	
8.2.5	HDMI In:	
8.2.6	HDMI Out:	
8.2.7	1Gbps Ethernet (specify electr./ opt., SM/MM):	
8.2.8	10Gbps Ethernet (specify electr./ opt., SM/MM):	
8.2.9	GPI:	
8.2.10	GPO:	
8.2.11	RS422/485 (specify)	
8.2.12	ASI/MADI/AES In electr.:	
8.2.13	ASI/MADI/AES In opt.:	
8.2.14	Analog Audio In:	
8.2.15	Analog Audio Out:	
8.2.16	Other opt. In (e.g. CAM-CCU/proprietary):	
8.2.17	Other opt. Out (e.g. CAM-CCU/proprietary):	
8.2.18	Comments:	

8.3 Loc C:

		<i>Please insert quantity</i>
8.3.1	SD-, HD-, 3G-SDI In:	
8.3.2	SD-, HD-, 3G-SDI Out:	
8.3.3	6G/12G SDI In:	
8.3.4	6G/12G SDI Out:	
8.3.5	HDMI In:	
8.3.6	HDMI Out:	
8.3.7	1Gbps Ethernet (specify electr./ opt., SM/MM):	
8.3.8	10Gbps Ethernet (specify electr./ opt., SM/MM):	
8.3.9	GPI:	
8.3.10	GPO:	
8.3.11	RS422/485 (specify)	
8.3.12	ASI/MADI/AES In electr.:	
8.3.13	ASI/MADI/AES In opt.:	
8.3.14	Analog Audio In:	
8.3.15	Analog Audio Out:	
8.3.16	Other opt. In (e.g. CAM-CCU/proprietary):	
8.3.17	Other opt. Out (e.g. CAM-CCU/proprietary):	
8.3.18	Comments:	

Contact your local Barnfind partner for
more information about Barnfind products.

Visit our web page for
application examples and downloads.

www.barnfind.no

A graphic featuring several overlapping, glowing blue and green arcs that resemble a network or data flow. The arcs are set against a dark blue background that transitions to a lighter green at the bottom. The text "a network of functions" is centered over the arcs in a white, sans-serif font.

a network of functions

BarnGuide Version 2.9



Barnfind Technologies AS

BarnOne | BarnMini | BarnStudio

Hinderveien 4, 3223 Sandefjord Norway

Org.no: 999 15 99 58